

OLYMPUS®

DIGITAL VOICE RECORDER

DM-670 DM-650

DETAILED INSTRUCTIONS

Thank you for purchasing an Olympus
Digital Voice Recorder.

Please read these instructions for information
about using the product correctly and safely.
Keep the instructions handy for future reference.

To ensure successful recordings, we recommend that
you test the record function and volume before use.



EN

Introduction

- The contents of this document may be changed in the future without advanced notice. Contact our Customer Support Center for the latest information relating to product names and model numbers.
- The illustration of the screen and the recorder shown in this manual may differ from the actual product. The utmost care has been taken to ensure the integrity of this document but if you find a questionable item, error or omission, please contact our Customer Support Center.
- Any liability for passive damages or damage of any kind occurred due to data loss incurred by a defect of the product, repair performed by the third party other than Olympus or an Olympus authorized service station, or any other reason is excluded.

Trademarks and registered trademarks

- IBM and PC/AT are the trademarks or registered trademarks of International Business Machines Corporation.
- Microsoft, Windows and Windows Media are registered trademarks of Microsoft Corporation.
- Macintosh and iTunes are the trademarks of Apple Inc.
- microSD and microSDHC are the trademarks of SD Card Association.
- MPEG Layer-3 audio coding technology licensed from Fraunhofer IIS and Thomson.
- EUPHONY MOBILE™ and DVM™ are the trademarks of DiMAGIC Corporation.
- The product was developed based on noise-canceling technology under license from NEC Corporation.
- Voice Activity Detection technology licensed from NTT Electronics Corporation.

Other product and brand names mentioned herein may be the trademarks or registered trademarks of their respective owners.



Table of contents

Introduction

Safety precautions	4
--------------------------	---

1 Getting started

Main features	8
---------------------	---

Checking the contents of the box	10
--	----

Identification of parts	11
-------------------------------	----

Display (LCD panel)	12
---------------------------	----

Power supply	15
--------------------	----

Inserting batteries	15
---------------------------	----

Battery settings	16
------------------------	----

Charging by connecting to a computer via USB	17
--	----

Connect to the USB connecting AC adapter	18
--	----

(optional) to charge	18
----------------------------	----

Turning on/off the power	20
--------------------------------	----

HOLD	21
-------------------	----

Setting time and date [Time & Date]	22
--	----

Changing the time and date	23
----------------------------------	----

Inserting and ejecting a microSD card	24
--	----

Inserting a microSD card	24
--------------------------------	----

Ejecting a microSD card	25
-------------------------------	----

[Home] display operations	26
--	----

Notes on the folders	27
-----------------------------------	----

About the folders for voice recordings	27
--	----

About the folder for music playback	28
---	----

About the folder for Podcast Contents	29
---	----

About the folder for Audible Contents	29
---	----

Selecting the folders and files	30
--	----

2 About recording

Recording	31
------------------------	----

Changing the recording scene [Rec Scene]	34
--	----

Recommended settings by recording condition	35
---	----

Recording from external microphone or other	36
---	----

devices	36
---------------	----

3 About playback

Playback	38
-----------------------	----

Playback Position mode	42
------------------------------	----

Changing the playback speed	44
-----------------------------------	----

Setting an index mark or a temp mark	45
--	----

How to begin segment repeat playback	46
--	----

Changing the playback scene [Play Scene]	47
--	----

Erasing	48
----------------------	----

Erasing files	48
---------------------	----

Erasing a folder	48
------------------------	----

Partially erasing a file	49
--------------------------------	----

4 Menu setting

Menu setting method	51
----------------------------------	----

 File Menu	53
---	----

 Rec Menu	53
--	----

 Play Menu	60
---	----

 LCD/Sound Menu	63
--	----

 Device Menu	64
---	----

Rearranging files [Replace]	66
-----------------------------------	----

Moving/Copying files [File Move/Copy]	67
---	----

Dividing files [File Divide]	69
------------------------------------	----

Timer recording [Timer Rec]	70
-----------------------------------	----

Alarm playback function [Alarm]	72
---------------------------------------	----

Guidance [Voice Guide] (DM-670 only)	75
--	----

Changing the USB class [USB Settings]	76
---	----

Formatting the recorder [Format]	77
--	----

5 Using the recorder on your PC

Operating environment	80
------------------------------------	----

Using Olympus Sonority	82
-------------------------------------	----

Functions available in the Olympus Sonority	82
---	----

Installing software	83
---------------------------	----

Uninstalling software	85
-----------------------------	----

Copying data from the Olympus Sonority	86
--	----

software	86
----------------	----

Upgrade function	87
------------------------	----

Using online help	89
-------------------------	----

Connecting to your PC	90
------------------------------------	----

Disconnecting from your PC	91
----------------------------------	----

Transfer the voice files to your PC	92
--	----

Usage as external memory of the PC	93
---	----

Using Audible content	94
------------------------------------	----

Loading Audible content	94
-------------------------------	----

Transferring Audible content	96
------------------------------------	----

Enjoy Audible content with the recorder	97
---	----

6 Other information

Alarm message list	101
---------------------------------	-----

Troubleshooting	103
------------------------------	-----

Accessories (optional)	106
-------------------------------------	-----

Specifications	107
-----------------------------	-----

Technical assistance and support	112
---	-----

1

2

3

4

5

6

EN

3

Safety precautions

Before using your new recorder, read this manual carefully to ensure that you know how to operate it safely and correctly. Keep this manual in an easily accessible location for future reference.

- The warning symbols indicate important safety related information. To protect yourself and others from personal injury or damage to property, it is essential that you always read the warnings and information provided.



Danger

If the product is used without observing the information given under this symbol, serious injury or death may result.



Warning

If the product is used without observing the information given under this symbol, injury or death may result.



Caution

If the product is used without observing the information given under this symbol, minor personal injury, damage to the equipment, or loss of valuable data may result.

Caution for usage environment

- **To protect the high-precision technology contained in this product, never leave the recorder in the places listed below, no matter if in use or storage:**
 - Places where temperatures and/or humidity are high or go through extreme changes. Direct sunlight, beaches, locked cars, or near other heat sources (stove, radiator, etc.) or humidifiers.
 - In sandy or dusty environments.
 - Near flammable items or explosives.
 - In wet places, such as bathrooms or in the rain. When using products with weatherproof designs, read their manuals as well.
 - In places prone to strong vibrations.
- **Never drop the recorder or subject it to severe shocks or vibrations.**
- **The recorder may malfunction if it is used in a location where it is subject to a magnetic/ electromagnetic field, radio waves, or high voltage, such as near a TV set, microwave, video game, loud speakers, large monitor unit, TV/radio tower, or transmission towers. In such cases, turn the recorder off and on again before further operation.**
- **Avoid recording or playing back near cellular phones or other wireless equipment, as they may cause interference and noise. If you experience noise, move to another place, or move the recorder further away from such equipment.**
- **Do not use organic solvents such as alcohol and lacquer thinner to clean the unit.**

Warning regarding data loss:

- Recorded content in memory may be destroyed or erased by operating mistakes, unit malfunction, or during repair work. It is recommended to back up and save important content to other media such as a computer hard disk.
- Any liability for passive damages or damage of any kind occurred due to data loss incurred by a defect of the product, repair performed by the third party other than Olympus or an Olympus authorized service station, or any other reasons is excluded from the Olympus's liability.

Handling the recorder



Warning:

- Do not use the recorder near flammable or explosive gases.**
- Keep young children and infants away from the recorder.**

Always use and store the recorder out of the reach of young children and infants to prevent the following dangerous situations which could cause serious injury:

 - ① Becoming entangled in the recorder strap, causing strangulation.
 - ② Accidentally swallowing the battery, cards or other small parts.
 - ③ Accidentally being injured by the moving parts of the recorder.
- Do not use or store the recorder in dusty or humid places.**
- Do not disassemble, repair or modify the unit yourself.**

- Use microSD/microSDHC memory cards only. Never use other types of cards.**

If you accidentally insert another type of card into the recorder, contact an authorized distributor or service center. Do not try to remove the card by force.

- Do not operate the unit while operating a vehicle (such as a bicycle, motorcycle, or car).**



Caution:

- Stop using the recorder immediately if you notice any unusual odors, noise, or smoke around it.**

Never remove the batteries with bare hands, which may cause a fire or burn your hands.

- Be careful with the strap.**

Be careful with the strap when you carry the recorder. It could easily catch on stray objects and cause serious damage.
- Do not leave the recorder in places where it may be subject to extremely high temperatures.**

Doing so may cause parts to deteriorate and, in some circumstances, cause the recorder to catch fire. Do not use the charger or AC adapter if it is covered (such as a blanket). This could cause overheating, resulting in fire.
- Handle the recorder with care to avoid getting a low-temperature burn.**
 - When the recorder contains metal parts, overheating can result in a low-temperature burn. Pay attention to the following:
 - When used for a long period, the recorder will get hot. If you hold on to the recorder in this state, a low-temperature burn may be caused.

- In places subject to extremely cold temperatures, the temperature of the recorder's body may be lower than the environmental temperature. If possible, wear gloves when handling the recorder in cold temperatures.

Battery handling precautions

Follow these important guidelines to prevent batteries from leaking, overheating, burning, exploding, or causing electrical shocks or burns.

Danger:

- Do not attempt to recharge alkaline, lithium or any other non-rechargeable batteries.
 - Batteries should never be exposed to flame, heated, short-circuited or disassembled.
 - Never heat or incinerate batteries.
 - Take precautions when carrying or storing batteries to prevent them from coming into contact with any metal objects such as jewelry, pins, fasteners, etc.
 - Never store batteries where they will be exposed to direct sunlight, or subjected to high temperatures in a hot vehicle, near a heat source, etc.
 - To prevent causing battery leaks or damaging their terminals, carefully follow all instructions regarding the use of batteries. Never attempt to disassemble a battery or modify it in any way, solder, etc.
 - Do not connect the battery directly to a power outlet or a cigarette lighter of an automobile.
- **If a battery fluid gets into your eyes, flush your eyes immediately with clear, cold running water and seek medical attention immediately.**

Warning:

- Keep batteries dry at all times.
- If rechargeable batteries have not been recharged within the specified time, stop charging them and do not use them.
- Do not use a battery if it is cracked or broken.
- Never subject batteries to strong shocks or continuous vibration.
- If a battery leaks, becomes discolored or deformed, or becomes abnormal in any other way during operation, stop using the recorder.
- If a battery leaks fluid onto your clothing or skin, remove the clothing and flush the affected area with clean, running cold water immediately. If the fluid burns your skin, seek medical attention immediately.
- Keep battery out of the reach of children.
- If you notice anything unusual when using this product such as abnormal noise, heat, smoke, or a burning odor:
 - ① remove the battery immediately while being careful not to burn yourself, and;
 - ② call your dealer or local Olympus representative for service.



Caution:

- **Please recycle batteries to help save our planet's resources. When you throw away dead batteries, be sure to cover their terminals and always observe local laws and regulations.**
- **Always charge a rechargeable battery when using it for the first time, or if it has not been used for a long period.**
- **Rechargeable battery have limited lifetime. When the operating time becomes shorter even if the rechargeable battery is fully charged under the specified condition, replace it with a new one.**

Getting started

Main features

1

Main features

- **Built-in 3-microphone system (high-sensitivity stereo microphones and central microphone).**

The combination of high-sensitivity stereo microphones and a central microphone enables balanced, wideband recordings from high to low frequencies.

- **Utilizes a high sensitivity, low noise stereo microphone capable of faithfully capturing the original sound.**
- **Supports the linear PCM format, which is capable of recording sound quality equivalent to or surpassing CD-level.**

Capable of realistically recording various different sound sources. High resolution recording at a high sampling frequency and bit count equivalent or superior to that of a music CD (Sampling frequency 44.1 kHz, Bit count 16bit) is possible (☞ P.54).

- **Supports a wide range of recording formats. Can handle the MP3 format (MPEG-1/ MPEG-2 Audio Layer 3) and the Windows Media Audio (WMA) format.**

This device can save files in a highly compressed manner, thereby allowing for extended recording times (☞ P.54). In addition, when connected to an external device, the recorder can encode incoming analog audio signals without a PC (☞ P.36).

- **You can playback WAV, WMA, and MP3 format files transferred from a computer in addition to files recorded by the device itself.**
This allows you to use this recorder as a music player.
- **Supports high capacity recording media. Besides the built-in memory, you can also record into a microSD card (☞ P.24).**

- **Equipped with a variety of features that support audio recording.**

With this recorder you can customize a variety of recording functions such as the recording level and microphone sensitivity to suit the recording conditions and personal preferences (☞ P.53).

- **It has a built-in Variable Control Voice Actuator (VCVA) function (☞ P.55).**
- **The Low Cut Filter minimizes air conditioner noise and other similar noises while recording (☞ P.55).**
- **A Noise Cancel function (☞ P.60) and a Voice Filter function (☞ P.60) cut noise and enable clear audio playback.**
- **Has recording scene setting and playback scene setting functions to register the best setting according to different usages (☞ P.34, P.47, P.58, P.62).**
- **It features various repeat functions (☞ P.46, P.61).**
- **EUPHONY MOBILE has been included to produce a natural, realistic experience without degrading sound quality (☞ P.60).**
- **You can move or copy files between the built-in memory and microSD card, and within the folders in the memory (☞ P.67).**
- **You can erase part of a PCM-format file that has been recorded with this recorder (☞ P.49).**
- **You can divide a file (PCM, MP3) that has been recorded with this recorder into two files (☞ P.69).**
- **Index mark and temp mark features allow you to quickly find desired locations (☞ P.45).**
- **The playback speed can be controlled as preferred (☞ P.44).**

- **The guidance feature (in English and other languages) gives audio notification of operating conditions (DM-670 only).**

This allows you to easily operate various functions with the support of the voice guidance (☞ P.75).

- **You may assign your own names to folders (☞ P.64).**
- **Timer Recording (☞ P.70) and Alarm playback (☞ P.72) enable automatic recording and playback at a set time.**
- **A convenient intro play feature has been included for when searching for a file that you want to listen to (☞ P.63).**
- **Comes with “Olympus Sonority” software for Windows and Macintosh (☞ P.80).**
 - If you transfer voice files recorded with the recorder to a PC, you can easily playback, organize, and edit the files.
 - You can perform waveform editing, file joining, and file splitting.
- **The “Olympus Sonority” can be upgraded to “Olympus Sonority Plus”, which is equipped with a enhanced functionality (Optional) (☞ P.87).**

In addition to the “Olympus Sonority” functions, editing of MP3 files and creation of music CDs can be performed.
- **This recorder is compatible with USB 2.0, enabling fast data transfer to a computer.**
- **It has a USB charging function (☞ P.17).**
- **It has a backlight full-dot display (LCD panel).**

- **It is compatible with Podcasting (☞ P.29).**

If favorite Podcast URLs are registered in the “Olympus Sonority”, the latest broadcasting content will be received automatically. Open the [Podcast] folder on the recorder to quickly listen to the program (file) transferred from the “Olympus Sonority”.

- **Compatible with Audible broadcasting (☞ P.94).**

Checking the contents of the box

The following items are included with the recorder.

If anything is missing or damaged, contact the dealer from whom you purchased the recorder.

1

Checking the contents of the box



Voice Recorder

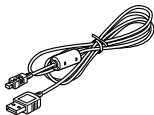

USB cable



Strap

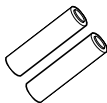

Ni-MH Rechargeable
batteries (2)

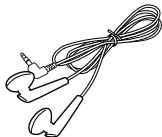

Earphone

- Carrying case
- Olympus Sonority CD-ROM
- Basic Manual
- Warranty card

- Contents may vary depending on purchase location.
- Warranty differs depending on purchase location. Warranty card may not be included.

■ Attaching the strap:

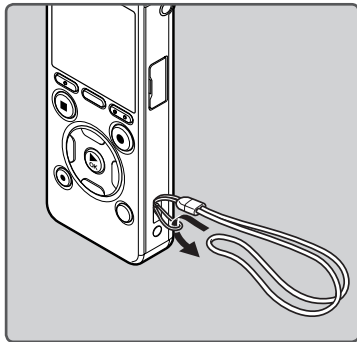

Identification of parts

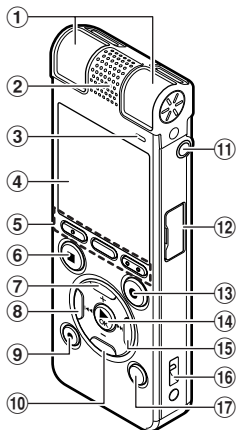

- ① Built-in stereo microphone (L/R)
- ② Built-in center microphone
- ③ LED indicator light (LED)
- ④ Display (LCD panel)
- ⑤ F1 button
MENU/SCENE button
F2 button
- ⑥ STOP (■) button
- ⑦ + button
- ⑧ MENU/SCENE button
- ⑨ ERASE button
- ⑩ - button
- ⑪ MIC (Microphone) jack
- ⑫ Card cover
- ⑬ REC (●) (Record) button

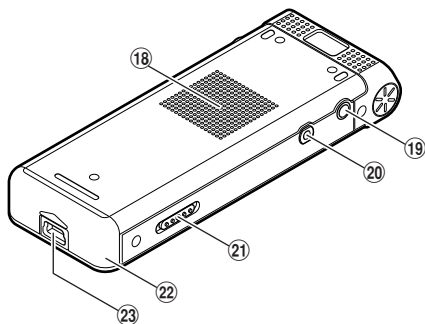

- ⑭ OK button
 - ⑮ Next button
 - ⑯ Strap hole
 - ⑰ LIST button
 - ⑱ Built-in speaker
 - ⑲ EAR (Earphone) jack
 - ⑳ REMOTE jack
- Connect the receiver for the exclusive remote control set RS30W (optional). This enables operation of the start and stop recording functions through the remote control.
- ㉑ POWER/HOLD switch
 - ㉒ Battery cover
 - ㉓ USB connector

Display (LCD panel)

■ [Recorder] mode display:

Folder list display

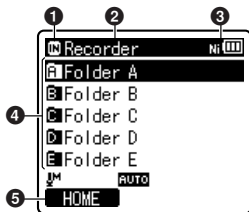

① Recording media indicator

[Ni]: Built-in flash memory

[C]: microSD card

② Current folder name

③ Battery indicator

④ Folder name

⑤ Function guide indicator

File list display

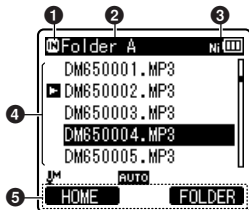

① Recording media indicator

② Current folder name

③ Battery indicator

④ File name

⑤ Function guide indicator

File display

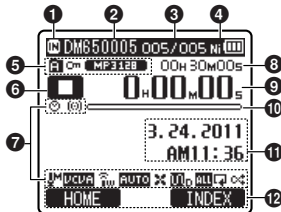

① Recording media indicator

② Current file name

③ Current file number/ Total number of recorded files in the folder

④ Battery indicator

⑤ Folder indicator, File Lock indicator, Recording mode indicator

⑥ Recorder status indicator

[▶]: Record indicator

[⏸]: Pause indicator

[⏹]: Stop indicator

[▶]: Play indicator

[▶▶]: Forwarding indicator

[◀◀]: Rewinding indicator

[▶F]: F. Play indicator

[S▶]: S. Play indicator

⑦ Icon display (P.14)

⑧ Remaining recording time, File length

⑨ Elapsed recording time, Elapsed playback time

⑩ Remaining memory bar indicator, Playback position bar indicator

⑪ Level meter, Recording date and time

⑫ Function guide indicator

■ [Music], [Podcast], [Audible], mode display:

List display ①

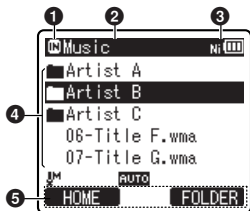

When there are files and folders in the folder

① Recording media indicator

[📀]: Built-in flash memory

[💻]: microSD card

② Current folder name

③ Battery indicator

④ Folder name, File name

⑤ Function guide indicator

List display ②

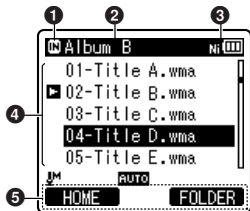

When there are only files in the folder

① Recording media indicator

② Current folder name

③ Battery indicator

④ File name

⑤ Function guide indicator

File display

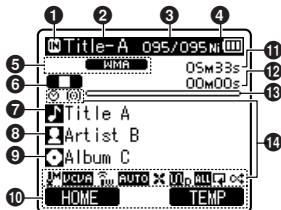

① Recording media indicator

② Current file name

③ Current file number/ Total number of recorded files in the folder

④ Battery indicator

⑤ File format

⑥ Recorder status indicator

[▶]: Play indicator

[⏏]: Stop indicator

[▶▶]: Forwarding indicator

[◀◀]: Rewinding indicator

[▶F]: F. Play indicator

[▶S]: S. Play indicator

⑦ Title name

⑧ Artist name

⑨ Album name

⑩ Function guide indicator

⑪ File length

⑫ Elapsed playback time

⑬ Playback position bar indicator

⑭ Icon display (see P.14)

Icon display (For all modes)

[🕒]: Timer

[🔔]: Alarm

[🎙️]: Microphone Sensitivity

[VCVA]: VCVA

[SYNC]: Voice sync

[AUTO]: Rec Level

[🔊]: Low Cut Filter

[🔍]: Zoom Mic

[🔇]: Noise Cancel

[🎧]: Voice Filter

[🎵] [🔊] [🔇]: Playback mode

[EUPHONY]: EUPHONY

[REVERB]: Reverb

1

Identification of parts

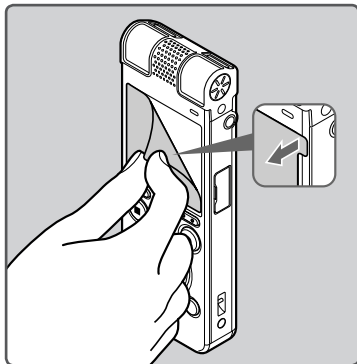

- Remove the screen protector on the display.

Power supply

Inserting batteries

This recorder can be used with either Ni-MH Rechargeable Batteries or AAA Alkaline Batteries.



- When charging with the recorder, be sure to use the supplied Ni-MH rechargeable batteries (BR404).
- The supplied rechargeable batteries are not fully charged. Before using the recorder or after long periods of disuse, it is recommended that you continuously charge them until full (see P.17).

- 1** Lightly press down on the arrow and slide the battery cover open.

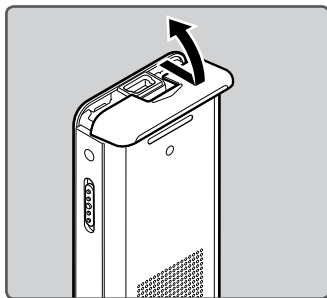

- 2** Insert the batteries, observing the correct \oplus and \ominus polarities.

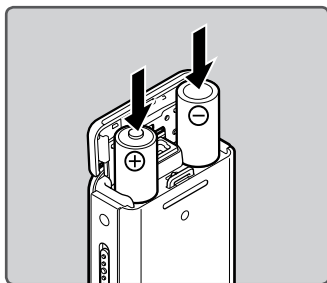

- 3** Close the battery cover completely by pressing to the direction **(A)**, then sliding to the direction **(B)**.

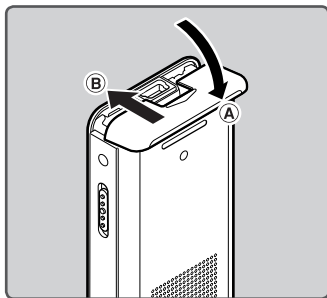

1

Power supply

Notes

- Manganese batteries may not be used in this recorder.
- When changing batteries, AAA alkaline batteries or Olympus Ni-MH rechargeable batteries are recommended.
- Be sure to stop the recorder before replacing the batteries. Unloading the batteries while the recorder is in use may cause a malfunction such as corrupting the file, etc. If you take out the batteries while recording, you will lose your currently recorded file because the file header will not be able to close.
- If it takes longer than 15 minutes to replace the dead batteries or if you take the batteries in and out repeatedly at short intervals, you may have to redo the battery and time settings. In this case, the **[Battery]** screen will appear. For more details, see **"Battery settings"**.
- Remove the batteries if you are not going to use the recorder for an extended period of time.
- When replacing rechargeable batteries, be sure to use Ni-MH rechargeable batteries (optional). The use of other manufacturers' products can damage the recorder and should be avoided.

1

Power supply

Battery settings

Select to match the battery you are using.

- 1 Replace the batteries and turn on the recorder (☞ P.15).**
- 2 Press the + or – button to change the setting.**

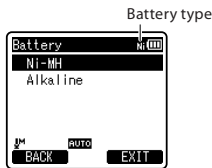

[Ni-MH] (☑):

Select when using the Olympus Ni-MH rechargeable batteries (BR404).

[Alkaline] (☐):

Select when using alkaline batteries.

- 3 Press the ►OK button to complete the setting.**
 - If the **"Hour"** indicator flashes in the display, see **"Setting time and date [Time & Date]"** (☞ P.22).

Battery indicator

The battery indicator on the display changes as the batteries lose power.



- When (☐) appears on the display, replace the batteries as soon as possible. When the batteries are too weak, [🔋] and **[Battery Low]** will appear on the display and the recorder will shut down.

Note

- When playing a voice/music file, the recorder may be reset due to the reduction of the voltage output of the batteries depending on the volume level even if [🔊] is displayed in the battery indicator. In this case, lower the volume of the recorder.

Charging by connecting to a computer via USB

You can charge the batteries by connecting to a PC's USB port. When charging, be sure to correctly place the rechargeable batteries (supplied) into the recorder (#P.15).



Before connecting the USB cable, exit HOLD mode (#P.21).

Do not charge primary batteries such as alkaline or lithium batteries. It may cause battery leakage or heating, which may cause the recorder to malfunction.

- 1 Boot the PC.**
- 2 Connect the USB cable to the USB port of the PC.**

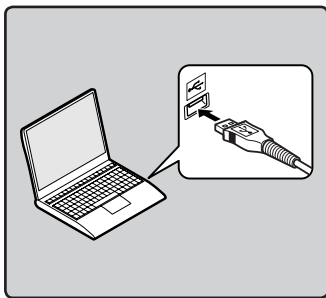

- 3 While the recorder is during stop mode or turned off, connect the USB cable to the connecting terminal on the bottom of the recorder.**

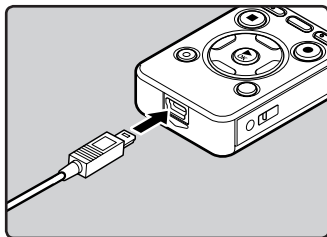

1

Power supply

- 4 Press the ►OK button to start charging.**



- While [Press OK to start charging] is flashing, press the ►OK button.

- 5 Charging is completed when battery indication becomes to [🔋].**



Charging time: approximately 3 hours *

- * It shows the approximate time when charging rechargeable batteries fully from no remaining power at the room temperature. The charging time

will be changed depending on the remaining amount and the state of batteries.

Connect to the USB connecting AC adapter (optional) to charge

It can be charged by connecting to the USB connecting AC adapter (A514) (optional).

1

Power supply



- Before connecting the AC adapter, switch the USB connection setting to **[AC Adapter]** (☞ P.76).
- Before connecting the USB cable, exit HOLD mode (☞ P.21).

1 Plug the recorder's USB cable into the AC adapter.

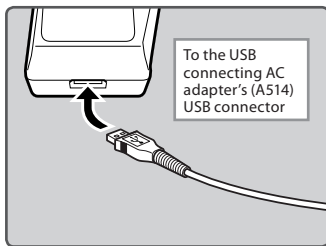

2 Plug the AC adapter into AC outlet.

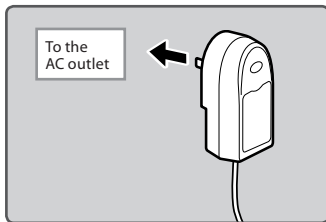

3 While the recorder is during stop mode or turned off, connect the USB cable to the connecting terminal on the bottom of the recorder.

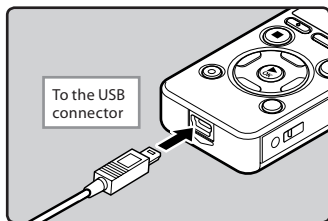

4 Press the ►OK button to start charging.



- While **[Press OK to start charging]** is flashing, press the ►OK button.

5 Charging is completed when [Battery Full] is displayed.

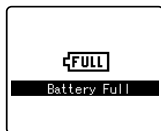

Notes

- The recorder cannot be charged when the PC is not turned on. It may not also be charged when the PC is in standby, hibernate, or sleep mode.

- Do not charge the recorder with the USB hub connected.
- Insert the supplied rechargeable battery and set **[Battery]** to **[Ni-MH]**. If **[Battery]** is set to **[Alkaline]**, you cannot recharge (☞ P.16, P.64).
- You cannot charge when **[☐]*1** or **[☐]*2** blinks. Charge the batteries at a temperature in the range of 5°C to 35°C (41°F to 95°F).
 - *1 **[☐]**: When the surrounding temperature is low.
 - *2 **[☐]**: When the surrounding temperature is high.
- When using time becomes notably short even after the batteries are fully charged, replace them with new ones.
- Be sure to push the USB connector all the way in. Otherwise, the recorder may not operate properly.
- Be sure to use the included dedicated USB cable. If any other company's cable is used, it may lead to malfunction of the recorder. Also, never use this dedicated cable with any other company's products.
- Selecting **[Composite]** in the USB connection settings will prevent the recorder to charge via USB. Select **[Storage class]** in the USB connection settings if you would like to charge (☞ P.76).
- In case you would like to charge using the **[Composite]** setting, select **[Optional]** in the USB connection settings, then connect the USB cable to the recorder. Selecting **[AC Adapter]** at the **[USB Connect]** display will enable you to charge (☞ P.76).

Cautions concerning the rechargeable batteries

Read the following descriptions carefully when you use the Ni-MH rechargeable batteries.

Discharging:

The rechargeable batteries self-discharge while this is not in use. Be sure to charge them regularly before use.

Operating temperature:

The rechargeable batteries are chemical products. The rechargeable batteries efficiency may fluctuate even when operating within the recommended temperature range. This is an inherent nature of such products.

Recommended temperature range:

When operating appliance:

0°C - 42°C/ 32°F - 107.6°F

Charging:

5°C - 35°C/ 41°F - 95°F

Storage for a long period:

-20°C - 30°C/ -4°F - 86°F

Using the rechargeable batteries outside the above temperature range may result in declining efficiency and shorter battery life. In order to prevent battery leakage or rust, remove the rechargeable batteries from the products when you will not be using them for a long time, and store them separately.

Notes

- This recorder is designed to fully charge batteries regardless of their energy level. However, for best results when charging newly purchased rechargeable batteries or batteries that have not been used for a long time (more than one month), it is recommended to fully charge the batteries then discharge repeatedly for 2 to 3 times.

- When disposing rechargeable batteries, always observe the local laws and regulations. Contact your local recycling center for proper disposal methods.
- If Ni-MH rechargeable batteries are not fully discharged, protect against short-circuiting (e.g. by taping the contacts) before disposing.

For customers in Germany:

Olympus has a contract with the GRS (Joint Battery Disposal Association) in Germany to ensure environmentally friendly disposal.

Turning on/off the power

When the recorder is not being used, turn the power off to reduce battery consumption to a minimum. Even if the power is turned off, existing data, mode settings, and clock settings will be maintained.

Turning on the power

While the recorder is turned off, slide the POWER/HOLD switch to the direction of the arrow.

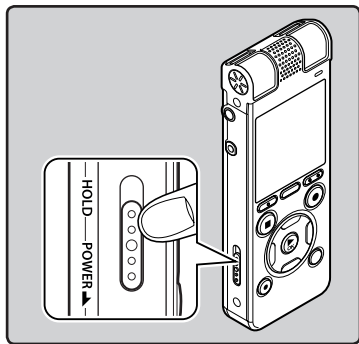

- The display will turn on, and the power will be turned on.

Turning off the power

Slide the POWER/HOLD switch to the direction of the arrow, and hold it for 0.5 seconds or longer.

- The display shuts off, and the power will be turned off.
- The resume function remembers the stop position before the power is turned off.

Power save mode

If the recorder is on and stops for 10 minutes or longer (default), the display shuts off and it goes into power save mode (P.64).

- To exit power save mode, press any button.

Notes

- When the power is turned on and off, the starting tune and closing tune will be played.
- If the recorder is formatted (P.77), the starting/closing tune data will also be erased, and the starting tune and closing tune will not be played. If you want to recover the starting/closing tune data, connect to the PC and copy the default sound data to the recorder by using the supplied "Olympus Sonority" (P.86).

HOLD

If you set the recorder to HOLD mode, the running conditions will be preserved, and all buttons will be disabled. This feature is useful when the recorder has to be carried in a bag or pocket. This mode can also prevent you from accidentally stopping the recording.

Set the recorder to HOLD mode

Slide the **POWER/HOLD** switch to the **[HOLD]** position.

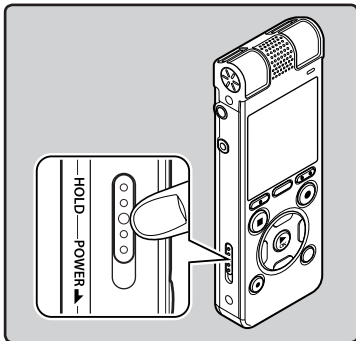

Exit HOLD mode

Slide the **POWER/HOLD** switch to the **(A)** position.

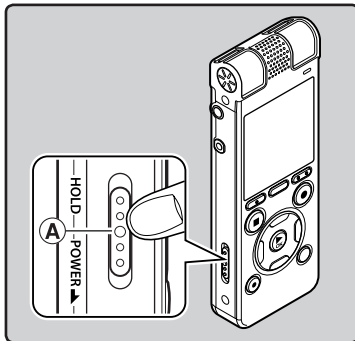

1

HOLD

- After **[Hold]** appears on the display, the recorder is set to HOLD mode.

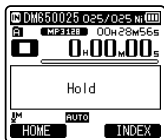

Notes

- If you press any button in HOLD mode, the clock display lights for 2 seconds, but the recorder will not operate.
- If HOLD is applied during playback (recording), operation is disabled with the playback (recording) state unchanged (When playback has ended or the recording has ended due to the remaining memory being used up, it will stop).
- The recorder can be effectively operated via the exclusive remote control set RS30W (optional), even when it is in HOLD mode.

EN

21

Setting time and date [Time & Date]

If you set the time and date beforehand, the information when the file is recorded is automatically stored for each file. Setting the time and date beforehand enables easier file management.

1

Setting time and date

When you use the recorder for the first time after purchasing it, or when the batteries have been inserted without the device having been used in a long time, the [Set Time & Date] will appear. When the "Hour" is flashing, conduct the setup from Step 1.

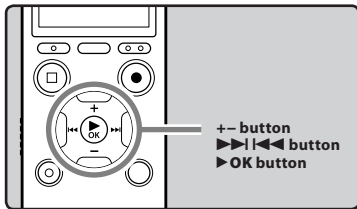

1 Press the >>> or <<< button to select the item to set.

- Select the item from the "Hour", "Minute", "Year", "Month" and "Day" with a flashing point.



2 Press the + or - button to set.

- Follow the same steps by pressing the >>> or <<< button to select the next item, and press the + or - button to set.

- You can select between 12 and 24 hour display by pressing the F1 button while setting the hour and minute.

Example: 10:38 P.M

10:38 PM (Initial setting) ↔ 22:38

- You can select the order of the "Month", "Day" and "Year" by pressing the F1 button while setting them.

Example: March 24, 2011

3M 24D 2011Y (Initial setting)

24D 3M 2011Y

2011Y 3M 24D

3 Press the >OK button to complete the setting.



- The clock will start from the set date and time. Press the >OK button according to the time signal.

Notes

- If you press the ►OK button during the setup operation, the recorder will save the items that were set to that point.

For DM-670:

- After setup, a message will sound saying that if the guidance is not required, select [Off], and the screen goes into [Voice Guide] (P.75) setup. If you don't want the guidance feature, select [Off].

Changing the time and date

While the recorder is during stop mode, press and hold the **STOP** (■) button to display the [Time & Date] and [Remain]. If the current time and date is not correct, set it using the procedure below.

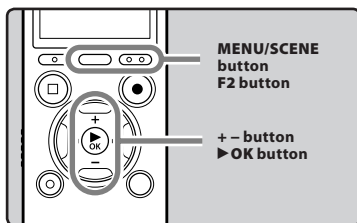

1 While the recorder is during stop mode, press the MENU/SCENE button.

- The menu will appear on the display (P.51).

2 Press the + or – button to select [Device Menu] tab.

- You can change the menu display by moving the settings tab cursor.



3 Press the ►OK button to move the cursor to the item to set.

- [Device Menu] will appear on the display.

4 Press the + or – button to select [Time & Date].



5 Press the ►OK button.

- [Time & Date] will appear on the display.
- The "Hour" will flash on the display, indicating the start of the Time and Date setup process.



The following steps are the same as Step 1 through Step 3 of "Setting time and date [Time & Date]" (P.22).

6 Press the F2 (EXIT) button to close the menu screen.

Inserting and ejecting a microSD card

The “microSD” indicated in the instruction manual refers to both microSD and microSDHC. With this recorder, besides the built-in memory, you can store the data into commercially available microSD card.

Inserting a microSD card

- 1 While the recorder is during stop mode, open the card cover.

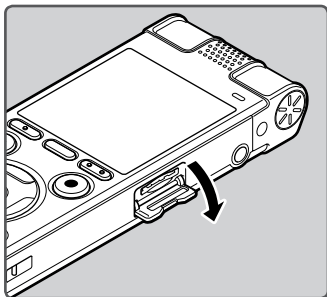

- 2 Face the microSD card in the correct way and insert it into the card slot as shown in the diagram.

- Insert the microSD card keeping it straight.

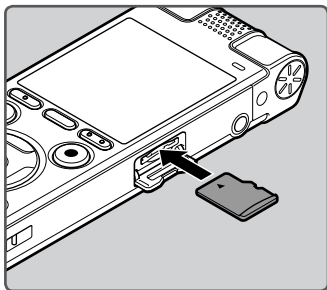

- Inserting the microSD card in the wrong way or at an angle could damage the contact area or cause the microSD card to jam.
- If the microSD card is not inserted all the way, data may not be written to the microSD card.

- 3 Close the card cover securely.

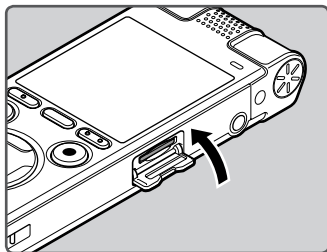

- When you insert the microSD card, the recording media changeover display will appear.

- 4 To record on a microSD card, press the + or – button and select [Yes].

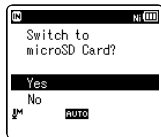

- 5 Press the ► OK button to complete the setting.

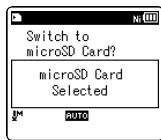

Notes

- It is possible to switch the recording media over to the built-in memory (☞ P.64).
- In some cases microSD cards that have been formatted (initialized) by another device, such as a computer, may not be recognized. Be sure to format microSD cards with this recorder before using them (☞ P.77).

Ejecting a microSD card

- 1 While the recorder is during stop mode, open the card cover.**
- 2 Push the microSD card inward to unlock it, and let it eject partially.**

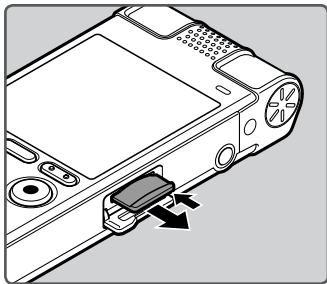

- The microSD card is visibly out of the slot and can be removed safely.
- If you eject the microSD card when **[Memory Select]** is set to **[microSD Card]**, it will be automatically changed to **[Built-in Memory Selected]**.

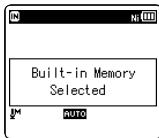

3 Close the card cover securely.

Notes

- Releasing your finger quickly after pushing the microSD card inward may cause it to eject forcefully out of the slot.
- Check the Olympus website regarding microSD cards which are confirmed operation with this recorder.
- This recorder may not recognize correctly on some microSD cards which are not compatible with this recorder.
- In the case when the microSD card cannot be recognized, remove the microSD card then put it in again to see if this recorder recognizes the microSD card.
- The processing performances reduce in a microSD card when you repeat writing and deleting. In this case, format the microSD card (☞ P.77).

[Home] display operations

1

[Home] display operations

You can use this recorder as a digital voice recorder, as well as a digital music player.

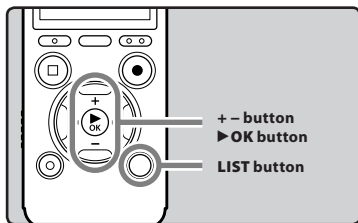

1 Press the LIST button repeatedly to set the [Home] display.

- [Home] will appear on the display.



- When [Home] is displayed in the Function Guide display section, press the F1 button to return to the home screen.

2 Press the + or - button to select the mode.



3 Press the ▶OK button.



When [Recorder] is selected:

The recorder will go into [Recorder] mode. You will be able to record and playback files recorded by the recorder (see P.31, P.38).

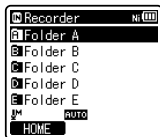

When [Music] (Audible) or [Podcast] is selected:

The recorder will go into [Music] (Audible) or [Podcast] mode, and you will be able to playback music files transferred to the recorder (see P.38).



Note

- During recording, you cannot switch the mode without stopping the recorder.

Notes on the folders

The built-in memory or the microSD card can be used for the recording media. Regardless of the recording media, voice files, music files, and contents files are separated and saved respectively into the **[Recorder]**, **[Music]**, **[Podcast]** and **[Audible]** folders organized in a branching tree-style.

About the folders for voice recordings

[Folder A] - **[Folder E]** within the **[Recorder]** folder are the folders for voice recordings. When recording with this recorder, select any one of the five folders and then record.

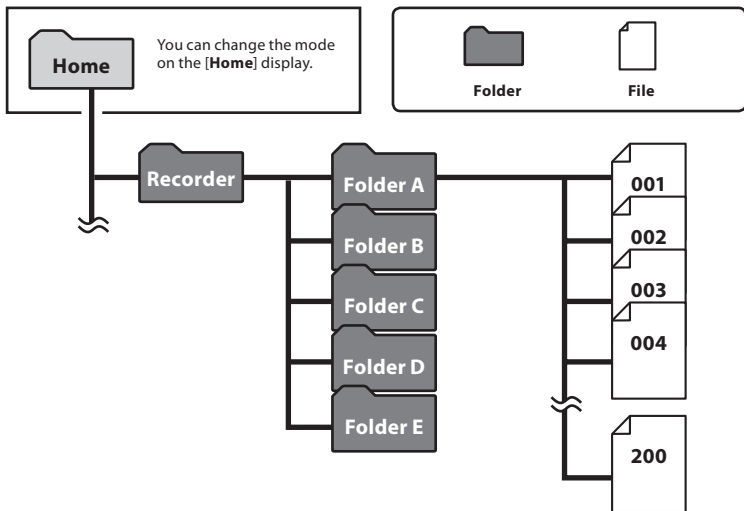

Each folder can store up to 200 files.

Note

- Files or folders located under the folder **[Recorder]** will not be indicated on the recorder.

About the folder for music playback

When transferring music files to the device using Windows Media Player, a folder is automatically created within the music playback folder which has a layered structure as shown in the diagram below. Music files that are in the same folder can be rearranged in preferential order and replayed (☞ P.66).

1

Notes on the folders

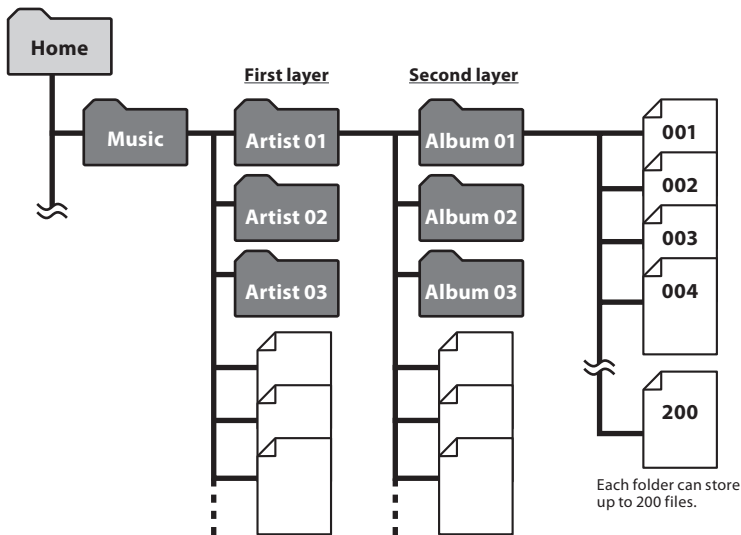

Up to 200 folders can be created under the [Music] folder, including [Music].



About the folder for Podcast Contents

A **[Podcast]** folder to store podcasts is prepared in advance. Programs (files) transmitted from the “Olympus Sonority” can be played. With the recorder stopped, open the **[Podcast]** folder at the **[Home]** menu to display a list of files and folders stored in the folder.

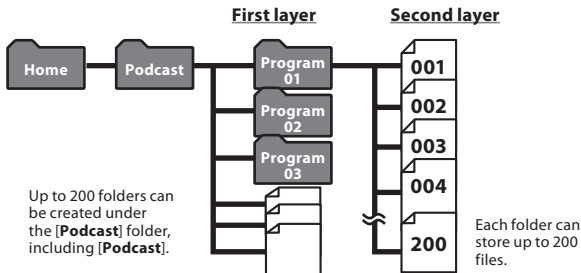

About the folder for Audible Contents

Audible files can be redirected from the Audible website to the recorder using the AudibleManager (P.94) or Windows Media Player.

When redirecting Audible files to this recorder using the AudibleManager, an **[Audible]** folder for playing Audible files will automatically be created in the **[Music]** folder, and the files stored there.

When redirecting Audible files to this recorder using the Windows Media Player, an **[Artist]** folder for playing will be created in the **[Music]** folder, just like for music files, and the files will be stored there.

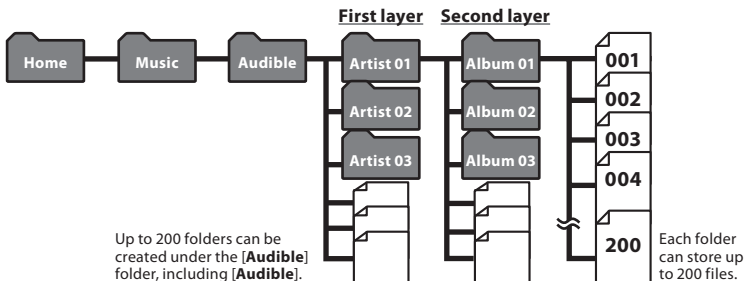

Selecting the folders and files

Change folders while the operation is stopped or during play. For information on the layered structure of the folders, see the section entitled “**Notes on the folders**” (P.27).

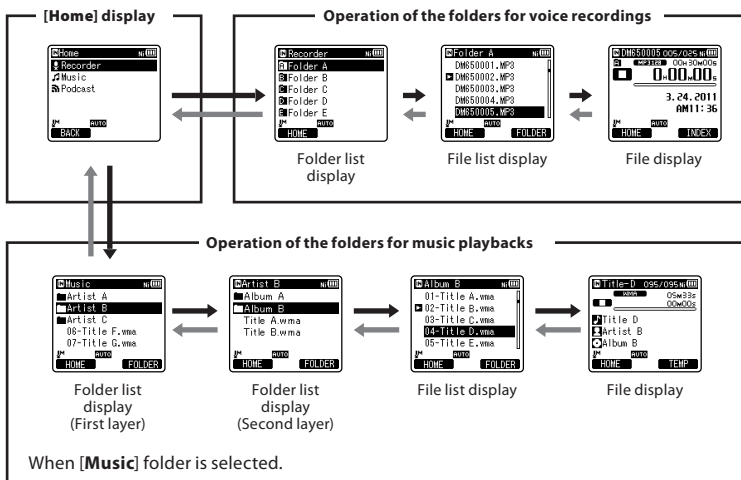

Moving through the levels

← Return: LIST button

Each time you press this it returns up one level. The ◀◀ button can also serve as the LIST button on a list display.

- When you press and hold the LIST button while moving in a hierarchy of folders, it will return to the file display.

→ Proceed: ► OK button

Each time you press this it opens the folder or file selected in the list display and proceeds down one level.

- The ►► button can also serve as the ► OK button on a list display.

+ or – button

Select the folder or file.

[Home] display:

Allows the mode of the recorder to be changed (P.26).

File display:

Information of the selected file is displayed. Enters in playback standby mode.

List display:

The folders and files recorded in this recorder are displayed.

About recording

Recording

Before starting recording, select a folder among [F1] to [F5]. These five folders can be selectively used to distinguish the kind of recording; for example, Folder [F1] might be used to store private information, while Folder [F5] might be dedicated to holding business information.

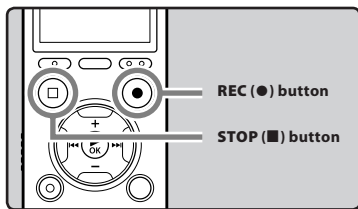

- 1 Select the recording folder (see P.27).
- 2 Press the REC (●) button to start recording.
 - The LED indicator light glows and [●] will appear on the display.
 - Turn the microphone in the direction of the source to be recorded.

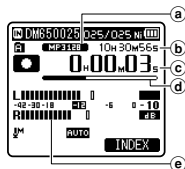

- a Recording mode indicator
- b Remaining recording time
- c Elapsed recording time
- d Remaining memory bar indicator
- e Level meter (changes according to the recording level and recording function settings)

- [Rec Mode] cannot be changed in the recording standby mode or while recording. Configure this while the recorder is stopped (see P.54).
 - This recorder is designed to be able to record cleanly and evenly, even in recording conditions such as when the volume of the source sound changes significantly. However, even higher sound quality recordings can be achieved by adjusting the recording level manually (see P.54).
 - Placing the built-in stereo microphone over the display is the proper position for performing stereo recording. If it is below the display when recording then proper stereo recording cannot be performed because the position of the original sound will be recorded in reverse phase.
- 3 Press the STOP (■) button to stop recording.

- [■] will appear on the display.

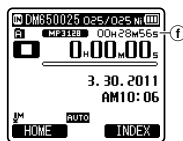

- f File length

Notes

- To ensure that you do not lose the beginning of the recording, verify that the LED indicator light or the mode indicator are lit on the display.

- When remaining recording time is less than 60 seconds, the LED indicator light starts flashing. When the recording time is decreasing to 30 or 10 seconds, the light flashes faster.
- **[Folder Full]** will appear when the recording cannot be made any further. Select other folder or delete any unnecessary files before recording (☞ P.48).
- **[Memory Full]** will appear when the memory is full. Delete any unnecessary files before recording any further (☞ P.48).
- When a microSD card is inserted in the recorder, be sure to confirm the recording media as either **[Built-in Memory]** or **[microSD Card]** so that there is no mistake (☞ P.64).
- If the **REC (●)** button is pressed when a function other than the record function is specified, **[Cannot record in this folder]** is displayed. Select a folder from **[Folder A]** through **[Folder E]** and start recording again.
- We recommend formatting the record media in the recorder before recording (☞ P.77).

It is possible to record exceeding 2GB:

The recording will continue even if the volume of a single file exceeds 2 GB in the linear PCM format recording.

- The file is saved every 2 GB in separate files. It will be treated as multiple files when playing back.
- When the recording exceeds 2 GB, the number of files in the folder may exceed 200 files. The 201st file and later will not be recognized by the recorder, so check by connecting the recorder to a PC.

Settings relating to Recording

[Mic Select] (ESP P.53)	Select whether or not the built-in center microphone is to be turned On or Off.
[Mic Sense] (ESP P.53)	Sets the recording sensitivity.
[Rec Mode] (ESP P.54)	Sets the recording rate for each recording format.
[Rec Level] (ESP P.54)	You can configure whether to adjust the recording level automatically or to adjust it manually.
[Zoom Mic] (ESP P.55)	Sets the directivity of the built-in stereo microphone.
[Low Cut Filter] (ESP P.55)	This function can reduce noise from air conditioners, projectors and other similar noises.
[VCVA] (ESP P.55)	Sets the threshold level for the Variable Control Voice Actuator (VCVA).
[V-Sync. Rec] (ESP P.56)	Sets the start level for voice sync recording.
[Timer Rec] (ESP P.70)	Sets timer recording.
[Rec Scene] (ESP P.58)	Sets the recording settings which matches the recording condition or environment.
[Rec Monitor] (ESP P.59)	Select whether or not to output the recording monitor sound from the EAR jack.

Pause

While the recorder is during recording mode, press the REC (●) button.

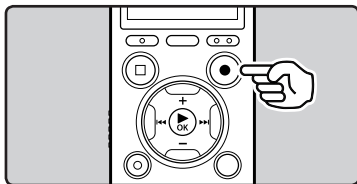

- [●] will appear on the display.
- The recorder will stop if left on pause for more than 120 minutes.

Resume Recording:

Press the REC (●) button again.

- Recording will resume at the point of interruption.

To quickly check on the recorded contents

While the recorder is during recording mode, press the ► OK button.

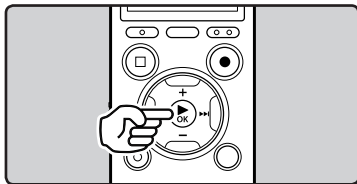

- [▶] will appear on the display.
- Recording will stop, and the file that was just recorded will be played back.

Listening while audio is recorded

If you start recording after inserting the earphone into the **EAR** jack on the recorder, you can hear the sound being recorded. The recording monitor volume can be adjusted by pressing the + or – button.

Connect the earphone to the EAR jack on the recorder.

- After recording has started, you can hear the sound being recorded through the earphone.

**Notes**

- Recording level cannot be controlled using the volume button.
- To avoid irritation to the ear, insert the earphone after turning down the volume level.
- Do not place earphones near a microphone as this may cause feedback.
- When the external speaker is connected while recording, there is a risk that audio feedback will occur. It is recommended that you use earphones for the recording monitor, or turn **[Rec Monitor]** to **[Off]** while recording (P.59).

**Changing the recording scene
[Rec Scene]**

You can easily change the recording settings by selecting the scene which best matches your usage (P.58).

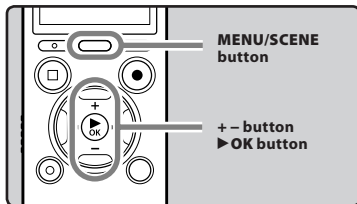

- While the recorder is during stop mode, press and hold the **MENU/SCENE** button.
- Press the + or – button to select **[Rec Scene]**.



- Press the **▶ OK** button.
- Press the + or – button to select the recording scene.

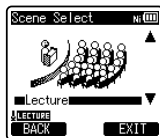

- Press the **▶ OK** button.

Recommended settings by recording condition

The recorder is initially set to [WMA 128 kbps] mode so that you can make high quality stereo recordings immediately after purchasing it. The various functions relating to recording can be configured in detail to suit the recording conditions. The following table shows the recommended settings for some example recording conditions.

Recording condition	Recommended settings			
	[Rec Mode] (P.54)	[Mic Sense] (P.53)	[Low Cut Filter] (P.55)	[Zoom Mic] (P.55)
Lectures in large rooms	[PCM]: [44.1kHz/16bit] [MP3]: [128kbps] [WMA]: [128 kbps]	[High]	[On]	[+6]
Conferences with a large number of people	[MP3]: [128kbps] [WMA]: [128 kbps]			[Off]
Meetings and business negotiations with a small number of people	[MP3]: [128kbps] [WMA]: [128 kbps]	[Middle]		
Dictation with a lot of background noise	[WMA]: [64 kbps]	[Low]	[Off]	
Music playing, wild birds singing, and railway sounds	[PCM]: [48kHz/16bit]	Set the microphone sensitivity according to the volume being recorded.		

File names will be automatically created for files recorded by this recorder.

DM65 0001 .WMA

①

②

③

① User ID:

The user ID name that has been set on the Digital Voice Recorder.

② File number:

A file number is consecutively assigned regardless of the changes in the recording media.

③ Extension:

These are the file name extensions for the recording format when recording with this device.

- Linear PCM format .WAV
- MP3 format .MP3
- WMA format .WMA

Recording from external microphone or other devices

The external microphone and other devices can be connected and the sound can be recorded. Connect as follows according to the device to be used.

- Do not plug and unplug devices into the recorder's jack while it is recording.

Recording with external microphone: Connect an external microphone to the MIC jack of the recorder.

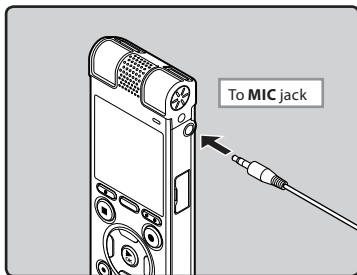

Applicable external microphones (optional) (P.106)

Stereo microphone: ME51S

The built-in large-diameter microphone enables sensitive stereo recording.

2-channel microphone (omni-directional): ME30W

These are highly sensitive omni-directional microphones supported by plug-in power which are well-suited to recording musical performances.

Compact Gun Microphone (unidirectional): ME31

The directional microphones useful for recordings such as outdoor recording of wild birds singing.

Compact zoom microphone (unidirectional): ME32

The microphone is integrated with a tripod, making it suitable to place on a table and record conferences or lecture from a distance.

Highly sensitive noise-cancellation monaural microphone (unidirectional): ME52W

This microphone is used to record sound at a distance while minimizing surrounding noise.

Tie clip microphone (omni-directional): ME15

Small concealing microphone with a tie-clip.

Telephone pickup: TP7

Earphone type microphone can be plugged into your ear while phoning. The voice or conversation over the phone can be clearly recorded.

Notes

- The built-in microphone will become inoperable when an external microphone is plugged into the recorder's MIC jack.
- Microphones supported by plug-in power can also be used.
- When an external monaural microphone is used while [Rec Mode] is set to a stereo recording mode, audio will be recorded to the L channel only (P.54).
- When an external stereo microphone is used while [Rec Mode] is set to a monaural recording mode, it enables recording only with the L channel microphone (P.54).

Recording the sound of other devices with this recorder:

The sound can be recorded when connecting to the audio output terminal (earphone jack) of the other device and the **MIC** jack of the recorder with the connecting cord KA333 (optional) for dubbing.

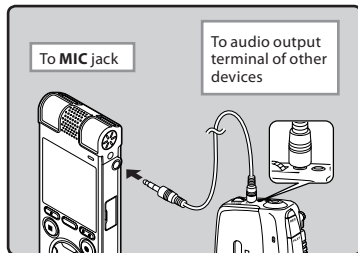

Note

- If you are unable to produce a clear recording with this recorder even after adjusting the recording level (☞ P.54), this could potentially be because the output level for the connected devices is too high or too low. When external devices are connected, perform a test recording and then adjust the output level for the external devices.

Recording the sound of this recorder with other devices:

The sound of this recorder can be recorded to other devices by connecting the audio input terminal (microphone jack) of other devices and the **EAR** jack of this recorder, with the connecting cord KA333 (optional).

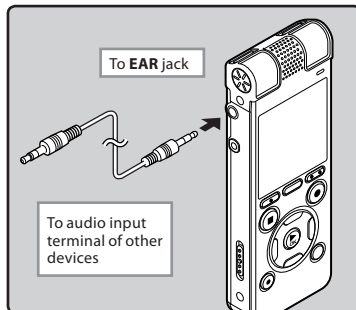

Note

- When you adjust the various sound quality settings related to playback on the recorder, the audio output signal sent out from the **EAR** jack will change as well (☞ P.60, P.62).

About playback

Playback

The recorder can play WAV, MP3 and WMA format files. To playback a file recorded with other machines, you need to transfer (copy) it from a computer.

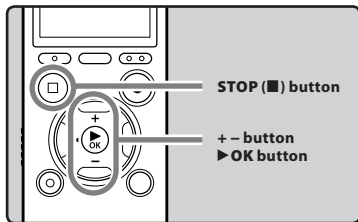

3 Playback

1 Select the file to be played back from the folder that contains it (P.30).

2 Press the ▶ OK button to start playback.

- [▶] will appear on the display.

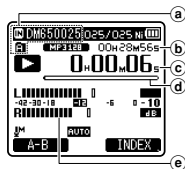

- (a) Recording media indicator, File name, Folder indicator
- (b) File length
- (c) Elapsed playback time
- (d) Playback position bar indicator
- (e) Level meter

3 Press the + or – button to adjust to a comfortable listening volume.

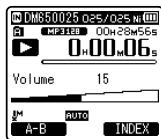

- The volume can be adjusted within a range from [00] to [30].

4 Press the STOP (■) button at any point you want to stop playback.

- [■] will appear on the display.
- This will stop the file being played back midway. When the resume function is activated the stopped location will be registered, even if the power is turned off. The next time the power is turned on, playback may be resumed from the registered stopped location.

Settings relating to playback

[Noise Cancel] (ESP P.60)	If recorded audio is difficult to understand because of noisy surroundings, adjust the Noise Cancel setting level.
[EUPHONY] (ESP P.60)	The EUPHONY setting can be set to one of the 4 levels according to your preference.
[Voice Filter] (ESP P.60)	The recorder has a Voice Filter Function to cut low and high frequency tones during normal, fast, or slow playback, and enable clear audio playback.
[Play Mode] (ESP P.61)	You can select the playback mode that fits your preference.
[Skip Space] (ESP P.61)	The skip interval length can be set.
[Alarm] (ESP P.72)	The alarm playback function can be set to play a selected file at a pre-set time.
[Play Scene] (ESP P.62)	Playback settings of your choice can be saved to suit different sound qualities and playback methods.
[Reverb] (ESP P.62)	You can enjoy the reverberant sound of various space sizes such as from the recording studio to the dome.

Playback through earphone

An earphone can be connected to the **EAR** jack of the recorder for listening.

- When the earphone is used, the recorder speaker will be switched-off.

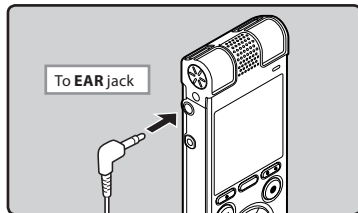

Notes

- To avoid irritation to the ear, insert the earphone after turning down the volume level.
- When you listen with the earphone during playback, do not raise the volume too much. It may cause hearing impairment and decrease in hearing ability.

Forwarding

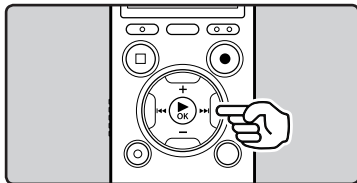

Rewinding

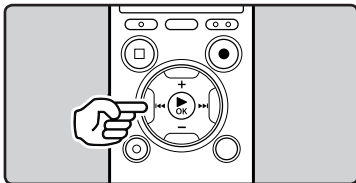

3

Playback

While the recorder is during stop mode in the file display, press and hold the ►► button.

- [▶▶] will appear on the display.
- If you release the ►► button, it will stop. Press the ►OK button to start playback from where it was stopped.

While the recorder is during playback mode, press and hold the ►► button.

- When you release the ►► button the recorder will resume normal playback.
- If there is an index mark or temp mark in the middle of the file, the recorder will stop at that location (☞ P.45).
- The recorder stops when it reaches the end of the file. Continue pressing the ►► button to proceed with the cue from the beginning of the next file.

While the recorder is during stop mode in the file display, press and hold the ◀◀ button.

- [◀◀] will appear on the display.
- If you release the ◀◀ button, it will stop. Press the ►OK button to start playback from where it was stopped.

While the recorder is during playback mode, press and hold the ◀◀ button.

- When you release the ◀◀ button the recorder will resume normal playback.
- If there is an index mark or temp mark in the middle of the file, the recorder will stop at that location (☞ P.45).
- The recorder stops when it reaches the beginning of the file. Continue pressing the ◀◀ button to proceed with the review from the end of the previous file.

Locating the beginning of a file

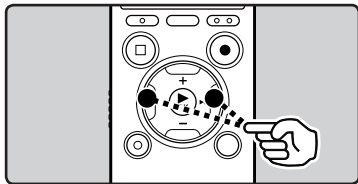

While the recorder is during stop mode or playback mode, press the **▶▶** button.

- The recorder skips to the beginning of the next file.

While the recorder is during playback mode, press the **◀◀** button.

- The recorder skips to the beginning of the current file.

While the recorder is during stop mode, press the **◀◀** button.

- The recorder skips to the beginning of the previous file. If the recorder is in the middle of a file, it will return to the beginning of the file.

While the recorder is during playback mode, press the **◀◀** button twice.

- The recorder skips to the beginning of the previous file.

Notes

- When you skip to the beginning of the file during playback, the recorder will stop at the position of the index mark or temp mark. The index mark and temp mark will be skipped when you perform the operation in stop mode (☞ P.45).
- When [Skip Space] is set to other than [File Skip], the recorder will skip forward/reverse the specified time, then will start playback (☞ P.61).

About music file

In cases where the recorder is unable to playback music files that have been transferred to it, check to make sure that the sampling rate and bit rate are in the range where playback is possible. Combinations of sampling rates and bit rates for music files which the recorder can playback are given below.

File format	Sampling frequency	Bit rate
WAV format	44.1 kHz, 48 kHz	16 bit
MP3 format	MPEG1 Layer3: 32 kHz, 44.1 kHz, 48 kHz MPEG2 Layer3: 16 kHz, 22.05 kHz, 24 kHz	From 8 kbps up to 320 kbps
WMA format	8 kHz, 11 kHz, 16 kHz, 22 kHz, 32 kHz, 44.1 kHz, 48 kHz	From 5 kbps up to 320 kbps

- Variable bitrate MP3 files (in which conversion bitrates can vary) may not be played back properly.
- For WAV files, this recorder can only play back those in the linear PCM format. WAV files other than these cannot be played back.
- Even if the file format is compatible for playback on this recorder, the recorder does not support every encoder.

Playback Position mode

The recorder has a playback position mode to automatically bookmark the latest position where you previously stopped playback for files transferred to the **[Podcast]** and **[Music]** (Audible) folders. Even if the recorder is stopped while a file is being played back, the last stop position is recalled from the file, and the file can be played back from that position next time.

3 Playback

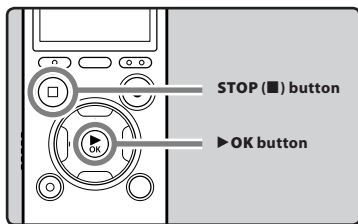

- 1 Select a content file in the **[Podcast]**, **[Music]** (Audible) folder.
- 2 Press the ▶ OK button to start playback.



- When you play a file that you previously played back, playback starts from the last stop position.

- 3 Press the **STOP (■)** button at any point you want to stop the playback.



- Stop a file playback at any point. The stop position is memorized as a Playback Position in the file. In this status, even if you select another file, move to a different folder, or turn the recorder off, the playback starts from the last memorized position when you play the same file.
- 4 Play back the contents file which has been played back halfway.
 - Press the ▶ OK button to start playing back from where it was stopped.

Forwarding

While the recorder is during stop mode, press and hold the ►►| button.

- When you release the button, the recorder stops. The Playback position is updated. If the ▶ OK button is pressed, playback starts from this position.

While the recorder is during playback mode, press and hold the ►►| button.

- When you release the button the recorder will resume normal playback.
- If an index mark (Ⓜ P.45) or Playback Position is marked in the middle of the file, the playback stops once at that position.
- The recorder stops when it reaches the end of the file. Continue pressing the ►►| button to proceed with the cue from the beginning of the next file.

Rewinding

While the recorder is during stop mode, press and hold the **⏮ button.**

- When you release the button, the recorder stops.
The Playback position is updated. If the **▶OK** button is pressed, playback starts from this position.

While the recorder is during playback mode, press and hold the **⏮ button.**

- When you release the button the recorder will resume normal playback.
- If an index mark (Ⓜ P.45) or Playback Position is marked in the middle of the file, the playback stops once at that position.
- The recorder stops when it reaches the beginning of the file. Continue pressing the **⏮** button to proceed with the review from the end of the previous file.
- If the **⏮** button is kept pressed while the recorder is stopped at the start of the top file, the recorder will fast rewind starting from the end of the last file.

Locating the Beginning of the File

While the recorder is during playback, slow playback, or fast playback, press the **▶▶I button.**

- The next file is cued and playback starts at the previously set speed.

While the recorder is during playback, slow playback, or fast playback, press the **⏮ button.**

- The file being played is cued and playback starts at the previously set speed.

While the recorder is during playback, slow playback or fast playback, press the **⏮ button twice.**

- The previous file is cued and playback starts at the previously set speed.
- If an index mark (Ⓜ P.45) is marked in the middle of the file, it reproduces from the position.
- If the skip space is set at other than file skip (Ⓜ P.61), the recorder will F. Skip (forward skip) or R. Skip (reverse skip) for a set time before playback.

To skip a file

While the recorder is during stop mode, press the **▶▶I button.**

- It skips to the Playback Position of the next file.

While the recorder is during stop mode, at the beginning of the file, press the **⏮ button.**

- It skips to the Playback Position of the previous file.

While the recorder is during stop mode, in the middle of the file, press the **⏮ button.**

- It skips to the beginning of the file.

Note

- If the file is deleted with this recorder, the Playback Position information is deleted simultaneously.

Changing the playback speed

Change the speed according to need such as listening to meeting content at a fast speed or reviewing spots that you couldn't catch in a language lesson at a slow speed. The tone will be automatically adjusted digitally without changing the voice so it sounds natural.

3 Playback

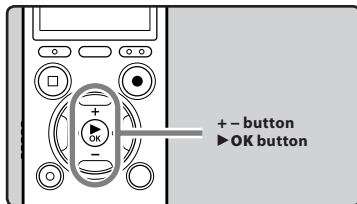

- 1 While the recorder is during playback mode, press the ▶ OK button.



- 2 Press the + or – button to select playback speed.



- 3 Press the ▶ OK button.

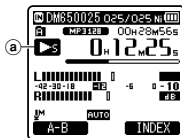

- a) Playback speed indicator
- Even if playback is stopped, the changed playback speed will be retained. The next playback will be at that speed.

About the limits of fast playback

Normal operation may not be available depending on the sampling frequency and the bit rate of the file to be played back. In such a case, reduce the speed of the fast playback.

Notes

- As in normal playback mode, you can stop playback, cue a file, or insert an index or temp mark in slow playback and fast playback modes as well (P.45).
- The slow playback or fast playback is available even if either [Voice Filter] is set (P.60).
- When using the slow playback or fast playback function, the following functions are not available.
 - [Noise Cancel] (P.60)
 - [EUPHONY] (P.60)
 - [Reverb] (P.62)

For DM-670:

- The [Speed] setting in the [Voice Guide] settings (P.75) is disabled during file playback.

Setting an index mark or a temp mark

If index marks and temp marks are placed, you can quickly find a location you want to listen to in fast forward and fast rewind and when cuing a file. Index marks can only be placed on files created by Olympus voice recorders, but temp marks can be placed instead to temporarily remember desired locations.

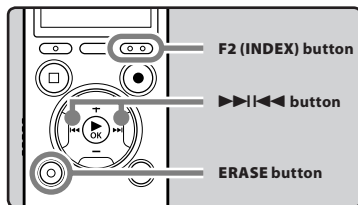

1 While the recorder is during recording mode or playback mode, press the F2 (INDEX) button.

- A number appears on the display and an index mark or temp mark will be placed.

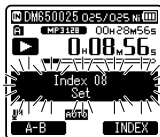

- Even after an index or temp mark is placed, recording or playback will continue so you can place index or temp marks in other locations in a similar manner.

Clearing an index mark or a temp mark

- Select a file in which index or temp marks you wish to erase are contained.
- Press the >>>|<<< button to select the index or temp mark to erase.

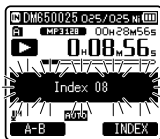

- While the index or temp number is displayed for approximately 2 seconds on the display, press the ERASE button.

- The index or temp mark is erased.

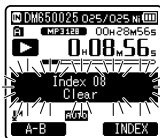

- Index or temp numbers after the erased index or temp number will be automatically decreased by 1.

Notes

- Temp marks are temporary markings, so if you transmit a file to the PC or move it with a PC, they will be automatically erased.
- Up to 16 (99*) index and temp marks can be set in a file. If you try to place more than 16 (99*) index or temp marks, [Index Full] message will appear for index marks, and [Temp Mark Full] for temp marks.
- Index or temp marks cannot be set or erased in a locked file (P.53).

* DM-670 only

How to begin segment repeat playback

This function enables repeated playback of part of the file being played.

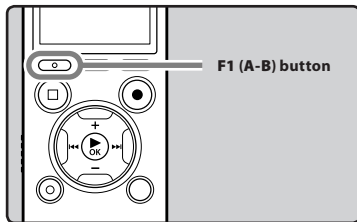

3

Playback

- 1 Select a file that has a segment you would like to play back repeatedly, and start playback.
- 2 Press the F1 (A-B) button at the point you want to start segment repeat playback.
 - **[A]** will flash on the display.



- You can fast forward, rewind, or change playback speed as you can operate in normal mode while **[A]** is flashing to find the end position (☞ P.44).
- When it reaches the end of the file while **[A]** is flashing, point **[B]** becomes the end of the file, and repeat playback will start.

- 3 Press the F1 (A-B) button again at the position where you want to end segment repeat playback.

- The recorder continuously plays back the segment until the segment repeat playback is canceled.



Note

- As in normal playback mode, playback speed can be changed during segment repeat playback as well (☞ P.44). If an index mark and temp mark are placed or cleared during segment repeat playback, segment repeat playback will be canceled and it will return to normal playback mode (☞ P.45).

Canceling the segment repeat playback function

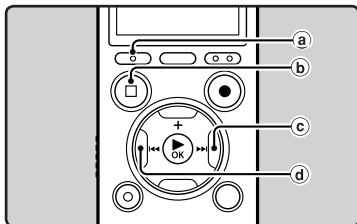

Pressing any of the following buttons will release the segment repeat playback.

- Press the F1 (CANCEL) button**
Pressing the F1 (CANCEL) button will release segment repeat playback, and it will return to normal playback mode.
- Press the STOP (■) button**
Pressing the STOP (■) button will release segment repeat playback, and stop playback.
- Press the ►►► button**
Pressing the ►►► button will release segment repeat playback, and make the recorder to skip to the beginning of the next file.
- Press the ◀◀◀ button**
Pressing the ◀◀◀ button will release segment repeat playback, and make the recorder to skip to the beginning of the current file.

Changing the playback scene [Play Scene]

If you register your preferred playback settings for the playback scenes, you can easily select the setting later (P.62).

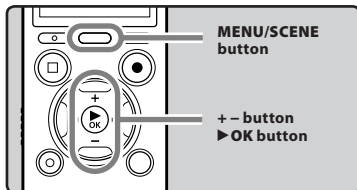

- While the recorder is during stop mode or playback mode, press and hold the MENU/SCENE button.**
- Press the + or – button to select [Play Scene].**

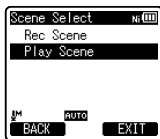

- Press the ► OK button.**
- Press the + or – button to select the playback scene.**

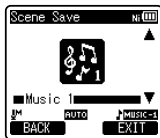

- Press the ► OK button.**

Erasing

Erasing files

A selected file can be erased from a folder. Also, all files in a folder can be erased simultaneously.

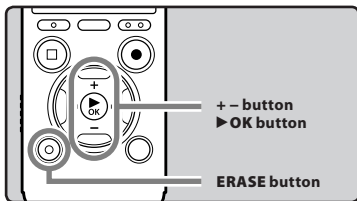

3

Erasing

- 1 Select the file you want to erase (see P.30).
- 2 While the recorder is during stop mode in the file display, press the ERASE button.
 - If an action is not selected within 8 seconds, the recorder will return to stop mode.
- 3 Press the + or – button to select [Erase in Folder] or [File Erase].



- 4 Press the ▶ OK button.
- 5 Press the + button to select [Start].



- 6 Press the ▶ OK button.

- The display changes to [Erase!] and erasing will start.
- [Erase Done] is displayed when the file is erased. File numbers will be reassigned automatically.

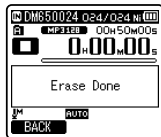

Erasing a folder

You can erase files by deleting folders.

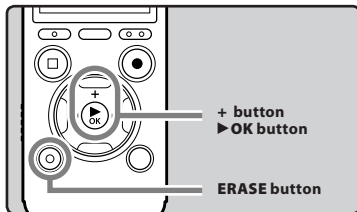

- 1 Select the folder you want to erase (see P.30).
- 2 While the recorder is during stop mode in the folder list display, press the ERASE button.
 - If an action is not selected within 8 seconds, the recorder will return to stop mode.

EN

48

- 3 Press the + button to select [Start].**



- 4 Press the ►OK button.**

- The display changes to **[Erase!]** and erasing will start.
- **[Erase Done]** is displayed when the folder is erased.

Partially erasing a file

An unwanted part of a file can be erased.



Only a PCM file recorded in the recorder can be partially erased.

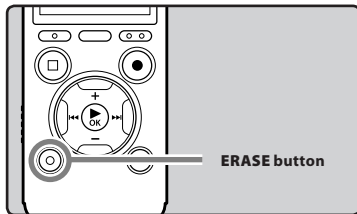

- 1 Play the file you want to partially erase.**

- Forward a file to the position that shall be erased. If the file is long, use the ►►| button to move to the position you want to delete.

- 2 In the starting position of the partial erase, press the ERASE button.**

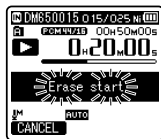

- While **[Erase start]** is flashing, playback continues and you can rewind or fast-forward as usual to locate the erase end position quickly. If the end of the file is reached while this indication is flashing, that position will become the erase end position.

- 3 In the position you want to end partial erase, press the ERASE button again.**



- **[Start point]** and **[End point]** on the display flash alternatively.

4 Press the ERASE button.

- The display will switch to **[Partial erasing !]** and start the partial erase. The deletion is completed when **[Partial erase completed.]** is displayed.
 - Playback will stop at the end location of the partial erase.
 - If you do not press the **ERASE** button within 8 seconds, the partial erase operation will be canceled and the recorder will return to playback mode.
- It may take over 10 seconds to complete processing. Never perform operations such as the following while processing, as they may damage the data. In addition, replace the battery with a new one in order to ensure that the battery will not run out while processing.
 - ① Disconnecting the AC Adapter while processing.
 - ② Removing the battery while processing.
 - ③ Remove the microSD card during processing when **[microSD Card]** is being used as the recording media.

Notes

- You cannot recover a file once it has been erased. Please check carefully before erasing.
- When an microSD card is inserted in the recorder, be sure to confirm the recording media as either **[Built-in Memory]** or **[microSD Card]** so that there is no mistake (☞ P.64).
- The file creation date will not change even if the file is partially erased.
- The locked files and files set as read-only cannot be erased (☞ P.53).
- The default folders of the recorder, namely **[Recorder]** (including **[Folder A]** to **[Folder E]**), **[Music]** and **[Podcast]** cannot be erased.
- In the **[Music]** and **[Podcast]** folder, all folders except **[Music]** and **[Podcast]** can be deleted.
- If there is a file that cannot be recognized by the recorder, the file and the folder which contains that file will not be erased. Please connect the recorder to your PC to erase.

Menu setting

Menu setting method

Items in menus are categorized by tabs, so select a tab first and move to a desired item to quickly set it. You can set each menu item as follows.

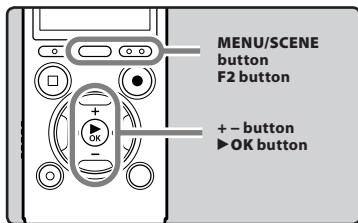

- 1 While the recorder is during stop mode, press the MENU/SCENE button.

- The menu will appear on the display.



- Menu items can be set during a recording or playback.

- 2 Press the + or - button to move to the tab that contains the item you want to set.

- You can change the menu display by moving the settings tab cursor.



- 3 Press the ▶OK button to move the cursor to the item to set.



- 4 Press the + or - button to move to the item you want to set.



- 5 Press the ▶OK button.

- Moves to the setting of the selected item.

- 6 Press the + or - button to change the setting.

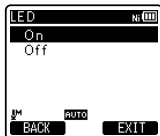

7 Press the ►OK button to complete the setting.

- You will be informed that the settings have been established via the screen.

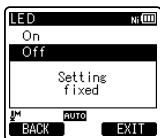

- Pressing the ◀◀ button without pressing the ►OK button will cancel the settings and return you to the previous screen.

8 Press the F2 (EXIT) button to close the menu screen.

- When in the menu screen during recording or playback, pressing the **F2 (EXIT)** button will allow you to return to the recording or playback screen without interrupting recording or playback.

Notes

- The recorder will stop if you leave it idle for 3 minutes during a menu setup operation, when a selected item is not applied.
- When entering menu settings during recording or playback, the menu settings will be canceled if 8 seconds elapse with no buttons being pressed.

Setting menu during recording:

Function	Setting
[Mic Sense]	
[Rec Level]	
[Zoom Mic]	
[Low Cut Filter]	To menu item options
[VCVA]	
[Rec Monitor]	
[Backlight]	
[LED]	

Setting menu during playback:

Function	Setting
[Property]	
[Noise Cancel]	
[EUPHONY]	
[Voice Filter]	
[Play Mode]	To menu item options
[Skip Space]	
[Reverb]	
[Backlight]	
[LED]	

File Menu

File Lock

Locking a file keeps important data from being accidentally erased. Locked files are not erased when you select to erase all files from a folder (P.48).

[On]: Locks the file and prevents it from being erased.

[Off]: Unlocks the file and allows it to be erased.

Replace

See “Rearranging files [Replace]” (P.66).

File Move/Copy

See “Moving/Copying files [File Move/Copy]” (P.67).

File Divide

See “Dividing files [File Divide]” (P.69).

Property

File and folder information can be confirmed from the menu screen.

When a file is selected:

[Name] (File name), **[Date]** (Time stamp), **[Size]** (File size), **[Bit Rate]*1** (File format), **[Artist]*2** (Artist name) and **[Album]*2** (Album name) will appear on the display.

*1 When a linear PCM format file has been selected, **[Bit Rate]** area displays the sampling frequency and bit rate.

*2 When a file contains no tag information, **[UNKNOWN_ARTIST]**, **[UNKNOWN_ALBUM]** will appear on the display.

When a folder is selected:

[Name] (Folder name), **[Folder]** (Number of folders) and **[File]*** (Number of files) will appear on the display.

- * Files which cannot be recognized by this recorder are not included in the number of files.
- Select a file for which you would like to verify information in advance before operating the menu.

Rec Menu

Mic Select

Select whether or not the built-in center microphone is to be turned On or Off.

[Central Mic ON]: Recording will be performed in 3-microphone mode.

[Central Mic OFF]: Recording will be performed, using only the built-in stereo microphones.

Mic Sense

Microphone sensitivity is adjustable to meet recording needs.

[High]: Highest recording sensitivity suitable for recording at a distance or low volume, such as conferences with a large number of people.

[Middle]: Suitable for recording meetings and seminars with a small number of people.

[Low]: Lowest recording sensitivity suitable for dictation.

- When you would like to clearly record a speaker's voice, set **[Mic Sense]** to **[Low]** and hold recorder's built-in stereo microphone close to the speaker's mouth (5-10 cm) when recording.

Rec Mode

The recorder can record in the linear PCM format. High resolution recording at a high sampling rate and high bit rate equivalent or superior to that of a music CD is possible. Moreover, it also supports the MP3 and WMA formats.

1 Select the recording format.

[PCM]: This is an uncompressed audio format which is used for music CDs and the like.

[MP3]: MPEG is the international standard established by a working group of the ISO (International Organization for Standardization).

[WMA]: This is an audio compression encoding method that was developed by the Microsoft Corporation in the US.

2 Select the recording rate.

When [PCM] is selected:

[48 kHz/16 bit] to [44.1 kHz/mono]*

When [MP3] is selected:

[320 kbps] to [mono]

When [WMA] is selected:

[128 kbps] to [mono]

* DM-670 only

- If the directional microphone function is used, you cannot change [PCM] setting in [Rec Mode] to one other than [44.1kHz/16 bit]. You can use the all modes in [MP3] or [WMA] of [Rec Mode].
- When [mono] of [MP3] is selected, the recording rate will be set to 64kbps.
- When [mono] of [WMA] is selected, the recording rate will be set to 8kbps.
- To record a meeting and lecture clearly, set [Rec Mode] to a position other than [mono].
- When the external monaural microphone is used while [Rec Mode] is set to a stereo recording mode, it enables recording only with the L channel microphone.

Rec Level

You can set the device to automatically or manually adjust the recording level.

[Manual]:

Recording is performed by manually adjusting the recording level.

[Auto]:

Recording is performed by automatically adjusting the recording level. This is useful for when you will be recording right away.

Adjust the recording level:

1 Press the ►►► or ◀◀◀ button while the recorder is recording or paused to adjust the recording level.

- The recording level will be automatically adjusted when the recording level is set to [Auto]. Set the recording level to [Manual] to use the recording level adjustment feature.
- When the recording level is set to [Manual], the limiter function will be disabled. Distorted sound will be recorded during [OVER] is displayed. Adjust the recording level so that [OVER] will not be displayed. If sound distortions do not disappear even after the recording level has been adjusted, change the setting for microphone sensitivity (ⓘ P.53) and adjust the recording level again.

- Inputting a very loud sound may produce noise even when the recording level is set to **[Auto]**.
- The level can be adjusted from **[01]** to **[16]**. The higher the number, the higher the level and the larger the indicator position on the level meter.

Zoom Mic

The directional microphone function utilizes DiMAGIC's (DiMAGIC Co., Ltd.) DiMAGIC Virtual Microphone (DVM) technology. DVM is an audio pickup system which allows you to record by focusing on sound from any direction. From expansive stereo recording to high directivity recording, DVM represents the latest in directional control methods that can be switched, using the built-in stereo microphone.

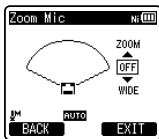

- When you increase the value, the directivity will narrow.
- Decreasing the value widens the directivity, enables you to record in a expansive stereo sound.
- If you reduce the directivity and widen the recording range, you can record in a sound with expansive stereo feeling.

About the Zoom Mic function:

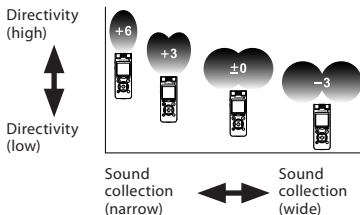

Low Cut Filter

The recorder has a Low Cut Filter function to minimize low-frequency sounds and record voices more clearly. This function can reduce noise from air conditioners, projectors and other similar noises.

[On]:

Enables the Low Cut Filter function.

[Off]:

Disables this function.

VCVA

When the microphone senses that sounds have reached a preset threshold volume level, the built-in Variable Control Voice Actuator (VCVA) starts recording automatically, and stops when the volume drops below the threshold level. The VCVA feature extends recording time and conserves memory by stopping recording during silent periods, which helps the playback to be more efficient.

1 Select **[On/Off]** or **[Standby]**.

2 Sets the VCVA function.

When **[On/Off]** is selected:

[On]:

Enables the VCVA function. Will start recording in VCVA mode.

[Off]:

Disables this function. Will resume recording in normal mode.

When [Standby] is selected:

[On]: With this setting, the recording monitor (earphone output) is disabled during VCVA standby (Ⓔ P.34), which allows you to confirm VCVA activation status by the earphone output.

[Off]: The audio signal is always output from the earphone jack.

Adjust the start/stop actuation level:**1 Press the REC (●) button to start recording.**

- When the sound volume is lower than the preset threshold sound level, recording automatically stops after 1 sec approximately, and **[Standby]** flashes on the display. The LED indicator light glows when recording starts and flashes when recording pauses.

2 Press the ►► or ◀◀ button to adjust the start/stop actuation level.

- The VCVA level can be set to any of 23 different values.
- The higher the value, the more sensitive the recorder will be to sounds. At the highest value, even the faintest sound will activate recording.

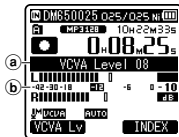

- a** Level meter (varies according to the sound volume being recorded)
- b** Start level (moves to the right/left according to the set level)

- When using the **[VCVA]** function, the following functions are not available.
 - [V-Sync. Rec]**
- When **[Rec Monitor]** is set to **[Off]**, the **[Standby]** function is disabled (Ⓔ P.59).
- If the start/stop actuation level is not adjusted within 2 seconds, the display will return to the previous one.
- If the surrounding noise is loud, the start/stop actuation sensitivity of the VCVA can be adjusted according to the recording situation.
- To ensure successful recordings, prior testing and adjustment of the start/stop actuation level is recommended.

V-Sync. Rec

Voice sync recording starts when a voice louder than the voice sync level (detection level) is detected. When the voice becomes low, recording will automatically stop. When voice sync recording is on and the input level falls below the voice sync level (detection level) for a period of at least the specified detection time, the recorder will return to the standby mode.

1 Select [On] or [Off].

[On]: Enables the Voice sync recording function.

[Off]: Disables this function.

- If you select **[On]**, proceed to the operation of Step 2.

2 Sets the detection time.

[1 second] [2 seconds] [3 seconds]
[4 seconds] [5 seconds] [10 seconds]:

- If the input (recording level) is equal to or below the specified level for longer than the specified detection time, the recorder will return to the standby mode.

Adjust the voice sync level:**1 Press the REC (●) button to start recording.**

- To use voice sync recording, set [V-Sync. Rec] to [On] and specify a detection time.

2 Press the ►► or ◀◀ button to adjust the voice sync level.

- The voice sync level can be set to any of 23 different values.
- The higher the value, the more sensitive the recorder will be to sounds. At the highest value, even the faintest sound will activate recording.

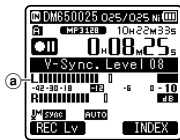

- Ⓐ Voice sync level (moves to the right/left according to the set level)

3 Press the REC (●) button again.

- The recorder will go into standby. [Standby] will flash on the display and the LED indicator light will flash.
- When the input is at or above the voice sync level, recording will start automatically.

4 Voice sync recording stops automatically.

- If sound at a volume below the voice sync level continues for the specified time, voice sync recording will end automatically, and the recorder will return to the standby mode of Step 3. Every time the recorder enters standby mode, the file will be closed and recording will continue in a different file.
- To stop the recorder during voice sync recording, press the STOP (■) button.
- When using the [V-Sync. Rec] function, the following functions are not available.
 - [VCVA] (☞ P.55)

Timer Rec

See "Timer recording [Timer Rec]" (☞ P.70).

RecScene

A recording setting can be selected from among the [Conference], [Lecture], [Meeting], [Dictation] or [DNS] templates to suit the recording scene or situation. You can also save a recording setting of your choice.

1 Select [Scene Select] or [Scene Save].

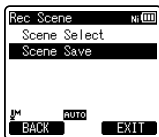

[Scene Select]: Select a recording scene from the templates which will suit the recording scene and conditions. For details, see “**Template settings**”. Alternatively, select recording scene customized for a particular purpose.

[Scene Save]: You can save up to 3 sets of menu settings relating to a current recording.

- If you select [Scene Select], proceed to the operation of Step 4.

When [Scene Save] is selected:

2 Set the recording settings according to your preferences.



3 Specify a save destination.

- You can select the save destination from [User Setting 1], [User Setting 2] and [User Setting 3].

When [Scene Select] is selected:

4 Select a recording scene.

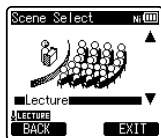

Template settings:

[Conference]:

[Mic Select]	[Central Mic ON]
[Mic Sense]	[High]
[Rec Mode]	[MP3]: [128 kbps]
[Rec Level]	[Auto]
[Zoom Mic]	[Off]
[Low Cut Filter]	[On]
[VCVA]	[On/Off]: [Off] [Standby]: [Off]
[V-Sync. Rec]	[Off]

[Lecture]:

[Mic Select]	[Central Mic ON]
[Mic Sense]	[High]
[Rec Mode]	[MP3]: [128 kbps]
[Rec Level]	[Auto]
[Zoom Mic]	[+6]
[Low Cut Filter]	[On]
[VCVA]	[On/Off]: [Off] [Standby]: [Off]
[V-Sync. Rec]	[Off]

[Meeting]:

[Mic Select]	[Central Mic ON]
[Mic Sense]	[Middle]
[Rec Mode]	[MP3]: [128 kbps]
[Rec Level]	[Auto]
[Zoom Mic]	[Off]
[Low Cut Filter]	[On]
[VCVA]	[On/Off]: [Off] [Standby]: [Off]
[V-Sync. Rec]	[Off]

[Dictation]:

[Mic Select]	[Central Mic ON]
[Mic Sense]	[Low]
[Rec Mode]	[MP3]: [mono]
[Rec Level]	[Auto]
[Zoom Mic]	[Off]
[Low Cut Filter]	[On]
[VCVA]	[On/Off]: [Off] [Standby]: [Off]
[V-Sync. Rec]	[Off]

[DNS]:

For Dragon Naturally Speaking
(Nuance Communications Inc.)

- When a recording scene is selected, recording-related menu settings cannot be changed. If you wish to use these functions, set **[Rec Scene]** to **[Off]**.

To check the settings:

On the **[Scene Select]** display, select a recording scene using the + and – buttons, and press the ►► button. Press the ◀◀ button to return to the **[Scene Select]** display.

Rec Monitor

Select whether or not to output audio from the earphone jack while recording.

[On]: Enables the recording monitor function. Sound will be output from the **EAR** jack.

[Off]: Disables this function. Sound will not be output from the **EAR** jack.

- When the external speaker is connected while recording, there is a risk that audio feedback will occur. It is recommended that you use earphones for the recording monitor, or turn **[Rec Monitor]** to **[Off]** while recording.

▶ Play Menu

Noise Cancel

If recorded audio is difficult to understand because of noisy surroundings, adjust the Noise Cancel setting level.

[High] [Low]: Enables the Noise Cancel function. Noise will be reduced in the file when it's played back for better sound quality.

[Off]: Disables this function.

- When using the **[Noise Cancel]** function, the following functions are not available.
 - Slow/Fast speed playback (Ⓜ P.44)
 - **[Voice Filter]**
 - **[EUPHONY]**
 - **[Reverb]** (Ⓜ P.62)

EUPHONY

This recorder is equipped with "EUPHONY MOBILE", the latest in surround sound systems which combines bandwidth correction, expansion technology, and virtual acoustical source processing technology. In addition to its natural, expansive feel, the recorder is equipped with the exceptional feature wherein listeners are less prone to developing a compressed or closed-in feel, or to growing tired over extended listening. On top of this, listeners are less prone to developing an oppressed or closed-in feel, or to growing tired over extended listening. Level adjustments of the EUPHONY setting can be set to four stages according to preference.

[Power]: This mode focuses more on lower sound registers.

[Wide]: This mode has an even more expansive feel.

[Natural]: This mode achieves natural bandwidth correction and acoustical field expansion.

[Off]: Disables this function.

- When using the **[EUPHONY]** function, the following functions are not available.
 - Slow/Fast speed playback (Ⓜ P.44)
 - **[Noise Cancel]**
 - **[Voice Filter]**
 - **[Reverb]** (Ⓜ P.62)
- When playing back using the built-in speaker, the EUPHONY function is disabled.

Voice Filter

The recorder has a Voice Filter Function to cut low and high frequency tones during normal, fast, or slow playback, and enable clear audio playback.

[On]: Enables the Voice Filter function.

[Off]: Disables this function.

- When using the **[Voice Filter]** function, the following functions are not available.
 - **[Noise Cancel]**
 - **[EUPHONY]**
 - **[Reverb]** (Ⓜ P.62)

Play Mode

You can select the playback mode that fits your preference.

Select the desired playback range:

1 Select [Play Area].

2 Select [File], [Folder] or [All].

[File]: Selects the current file.

[Folder]: Selects the current folder.

[All]: Selects all files in the current memory.

Select the desired playback mode:

1 Select [Repeat] or [Random].

[Repeat]: Sets to repeat playback mode.

[Random]: Sets to random playback mode.

2 Select [On] or [Off].

[On]: Sets the playback range to be played back repeatedly or randomly.

[Off]: Disables this function.

- In [File] mode, when the recorder comes to the end of the last file in the folder, [End] flashes for two seconds on the display and the recorder stops at the start of the last file.
- In [Folder] mode, when the recorder comes to the end of the last file in the folder, [End] flashes for two seconds on the display and the recorder stops at the start of the first file in the folder.
- In [All] mode, after playing the last file in the folder, the recorder will start playing from the first file in the next folder. When it comes to the end of the last file in the recorder, [End] flashes for two seconds on the display and the recorder stops at the start of the first file in the recorder.

Skip Space

This function enables you to skip (forward) or reverse skip (rewind) a file being played for a set period. This function is convenient for quickly skipping to another playback position or repeatedly playing back short phrases.

1 Select [Forward Skip] or [Reverse Skip].

2 Set the skip space.

When [Forward Skip] is selected:

[File Skip] [10sec. Skip] [30sec. Skip]

[1min. Skip] [5min. Skip]

[10min. Skip]

When [Reverse Skip] is selected:

[File Skip] [1sec. Skip] to [5sec. Skip]

[10sec. Skip] [30sec. Skip]

[1min. Skip] [5min. Skip]

[10min. Skip]

Forward/Reverse Skip Playback:

1 Press the ► OK button to start playback.

2 Press the ►► or ◀◀ button.

- The recorder will skip (forward) or reverse skip (rewind) a set space and start playing back.
- If there is an index mark/temp mark or a cue closer than the skip space, the recorder will forward skip/reverse skip to that position.

Alarm

See “Alarm playback function [Alarm]” (P.72).

Play Scene

Voice files recorded in the recorder and music files downloaded from the PC can be saved in the playback settings of your choice to suit the different sound qualities and playback methods.

1 Select [Scene Select] or [Scene Save].

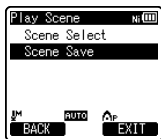

[Scene Select]: Select a playback scene customized to your preferences.

[Scene Save]: You can save up to 5 sets of menu settings relating to a current playback.

- If you select **[Scene Select]**, proceed to the operation of Step 4.

When [Scene Save] is selected:

2 Set the playback settings according to your preferences.



3 Specify a save destination for the settings.

- You can select the save destination from among **[Voice 1]** to **[Music 3]**.

When [Scene Select] is selected:

4 Select a playback scene.

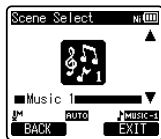

To check the settings :

On the **[Scene Select]** display, select a playback scene using the + and – buttons, and press the ►► button. Press the ◀◀ button to return to the **[Scene Select]** display.

Reverb

You can enjoy the reverberant sound of various space sizes such as from the recording studio to the dome.

[Off]: Disables the reverb function. Select this when playing back original sounds as they are.

[Studio] [Club] [Hall] [Dome]: Select the preferred acoustical environment.

- This function is only available during playback. This recorder cannot perform recording by using the playback results.
- When using the **[Reverb]** function, the following functions are not available.
 - Slow/Fast speed playback (Ⓜ P.44)
 - **[Noise cancel]** (Ⓜ P.60)
 - **[EUPHONY]** (Ⓜ P.60)
 - **[Voice Filter]** (Ⓜ P.60)

LCD/Sound Menu

Backlight

The display will remain lit for about 10 (Initial setting) seconds when a button on the recorder is pressed.

1 Select [Lighting Time] or [Brightness].

2 Select the setting.

When [Lighting Time] is selected:
[Off]:

Disables this function.

[5seconds] [10seconds] [30seconds]
[1minute]:

Enables the Backlight function.

When [Brightness] is selected:
[High] [Low]:

Sets the brightness of the backlight when lit.

Contrast

Display contrast can be adjusted in 12 levels.

- You can adjust the LCD display contrast level from [01] to [12].

LED

You can set it so the LED indicator light does not turn on.

[On]: LED light will be set.

[Off]: LED light will be canceled.

Beep

The recorder beeps to alert you to button operations or warn you of errors. System sounds may be turned off.

[Volume3]:

Increase the volume of beeps.

[Volume2]:

Return the volume of beeps to normal.

[Volume1]:

Decrease the volume of beeps.

[Off]: Disables this function.

For DM-650:

- The starting/closing tune that plays when the power is turned on/off (P.20) can be deactivated by setting it to [Off].

Language(Lang)

You can select the display language for this recorder.

[English] [Français] [Deutsch] [Italiano]
[Español] [Русский]:

- The selectable languages differ depending on the region.

Voice Guide (DM-670 only)

See "Guidance [Voice Guide] (DM-670 only)" (P.75).

Intro Play

You can listen to the first few seconds of a file by touching the cursor to a file within a folder. This feature is convenient when looking for files.

[10seconds]:

The first 10 seconds of a file will be played.

[5seconds]:

The first 5 seconds of a file will be played.

[3seconds]:

The first 3 seconds of a file will be played.

[Off]:

Disables this function.

🔍 Device Menu

Memory Select

When a microSD card is inserted you can select to record to either the built-in memory or to the microSD card (☞ P.24).
[Built-in Memory]: Built-in memory.
[microSD Card]: microSD card.

Power Save

Forgetting to turn the power off can be prevented. If the recorder remains in stop mode for over 10 minutes (Initial setting) while the power is turned on, the power will be turned off.

[5minutes] **[10minutes]** **[30minutes]**
[1hour]:

Set the length of time before the power will be turned off.

[Off]: Disables this function.

- If any button is pressed, the elapsed time count before the power turns off will start over again.

Battery

Select to match the battery you are using.

[Ni-MH] (🔋):

Select when using the Olympus Ni-MH rechargeable batteries (BR404).

[Alkaline] (🔋):

Select when using alkaline batteries.

Folder Name

You can change the folder names of Folder **F1** to Folder **F1** for audio recording into names preset in the template. You can also change folder names registered in the template with "Olympus Sonority".

1 Select a folder that you want to rename.

2 Select a folder name from the preset templates.

Time & Date

See "**Setting time and date [Time & Date]**" (☞ P.22).

USB Settings

See "**Changing the USB class [USB Settings]**" (☞ P.76).

Reset Settings

This returns the functions back to their initial settings (factory default).

[Start]: Returns the settings to their initial values.

[Cancel]: Takes you back to **[Device Menu]**.

- After resetting the settings, the time settings, file numbers and folder name will be preserved, without returning to their initial settings.

Menu settings after resetting (initial settings):

🔍 Rec Menu:

[Mic Select]	[Central Mic ON]
[Mic Sense]	[Middle]
[Rec Mode]	
[WMA]	[128 kbps]
[Rec Level]	[Auto]
[Zoom Mic]	[Off]
[Low Cut Filter]	[Off]
[VCVA]	[Off]
[On/Off]	[Off]
[Standby]	[Off]
[V-Sync. Rec]	[Off]
[Timer Rec]	[Off]
[Rec Scene]	[Off]
[Rec Monitor]	[Off]

▶ Play Menu:

[Noise Cancel]	[Off]
[EUPHONY]	[Off]
[Voice Filter]	[Off]
[Play Mode]	
[Play Area]	[File]
[Repeat]	[Off]
[Random]	[Off]
[Skip Space]	
[Forward Skip]	[File Skip]
[Reverse Skip]	[File Skip]
[Alarm]	[Off]
[Play Scene]	[Off]
[Reverb]	[Off]

▶ LCD/Sound Menu:

[Backlight]	
[Lighting Time]	[10Seconds]
[Brightness]	[Low]
[Contrast]	[Level 06]
[LED]	[On]
[Beep]	[Volume 2]
[Language(Lang)]	[English]
[Voice Guide]*	
[On/Off]	[On]
[Speed]	[Speed 3]
[Volume]	[Volume 3]
[Intro Play]	[Off]

▶ Device Menu:

[Memory Select]	[Built-in Memory]
[Power Save]	[10minutes]
[Battery]	[Ni-MH]
[USB Settings]	
[USB Connect]	[PC]
[USB Class]	[Storage class]

* DM-670 only

Format

See “**Formatting the recorder [Format]**”
(EN P.77).

Memory Info.

The recordable capacity remaining and overall capacity of the recording media can be seen from the menu.

- The recorder will use some capacity of the memory to keep the management file. For microSD card, the remaining capacity will be shown less than the total capacity of the card due to characteristic of the microSD card, but this is not a malfunction.

System Info.

You can check the recorder’s information on the menu screen. **[Model]** (Model Name), **[Version]** (System version) and **[Serial No.]** (Serial Number) appear on the display.

Rearranging files [Replace]

You can move a file in a folder to change the order of playback. First select the folder (file) for which you want to change the playback order.

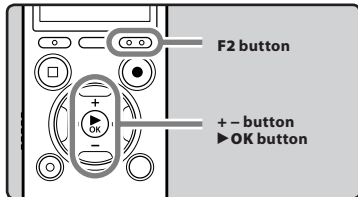

4

Menu setting method

- 1 Select the folder for which you would like to rearrange the file order (see P.30).
- 2 Select [Replace] from the menu on the [File Menu].
 - For details on how to enter the menu settings, see "Menu setting method" (see P.51).
- 3 Press the + or – button to select the file you want to move.

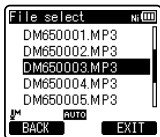

- 4 Press the ▶OK button.
 - The cursor will flash to confirm that the file can be moved.

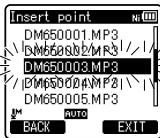

- 5 Press the + or – button to select the location to move it to.



- 6 Press the ▶OK button to complete the setting.
 - If there are more files to move, repeat Steps 3 through 6.
 - Pressing the ◀◀ button without pressing the ▶OK button will cancel the settings and return you to the previous screen.
- 7 Press the F2 (EXIT) button to close the menu screen.

Moving/Copying files

[File Move/Copy]

Files saved in the built-in memory or the microSD card can be moved or copied within the memory. Files can also be moved or copied between memory.

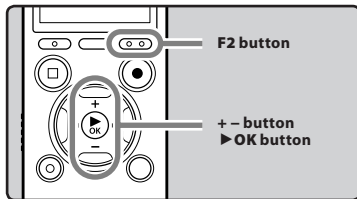

- 1 Select the folder where the file you want to move or copy is saved (☞ P.30).
- 2 Select [File Move/Copy] from the menu on the [File Menu].
 - For details on how to enter the menu settings, see "Menu setting method" (☞ P.51).
- 3 Press the + or – button to select the position to move or copy the file to.

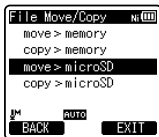

[move > memory]:

Move a file in the built-in memory or microSD card to another folder within the built-in memory.

[copy > memory]:

Copy a file in the built-in memory or microSD card to another folder within the built-in memory.

[move > microSD]:

Move a file in the built-in memory or microSD card to another folder in the microSD card.

[copy > microSD]:

Copy a file in the built-in memory or microSD card to another folder in the microSD card.

- 4 Press the ▶OK button.
- 5 Press the + or – button to select the number of files to move or copy.



[1file]:

Select only the specified file.

[Selected files]:

Select multiple files.

[All files]:

Select all files in the folder.

- 6 Press the ▶OK button to move to the respective setting.

When you select [1file]:

- 1 Press the + or – button to select the file you want to move or copy.
- 2 Press the ►OK button to select the file.

When you select [Selected files]:

- 1 Press the + or – button to select the file you want to move or copy.
- 2 Press the ►OK button to check the file(s) selected.

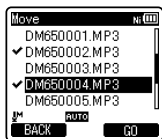

- 3 Repeat steps 1 and 2 until all the files you want to move/copy are selected then press the F2 (GO) button.

When you select [All files]:

When all files are selected, all the files in the folder will be automatically selected and the recorder will move to the [Folder to move] screen.

- 7 Press the ►►, ◀◀ or +, – button to select the folder you want to move or copy the file to.



- 8 Press the F2 (GO) button.

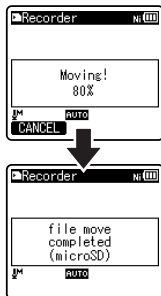

- File move or file copy will start if [Moving!] or [Copying!] appears on the display. During the process, the progress status will be shown in percentage. The process is completed when [File move completed] or [File copy completed] is displayed.

Notes

- The recorder cannot copy when the memory capacity is not sufficient.
- The recorder cannot move or copy when the number of files exceeds 200.
- Do not remove the batteries during moving or copying. This may damage the data.
- A file cannot be moved or copied to the same folder.
- When the operation is canceled during moving or copying, only the operation on the file that is being moved or copied is effective, all other files will not be moved or copied.
- Files which are locked will remain so even after they are moved or copied.
- DRM files cannot be moved or copied.
- Files cannot be moved or copied directly under the [Recorder] folder.

Dividing files [File Divide]

Files with large capacities and long recording times can be divided so that they are easier to manage and edit.

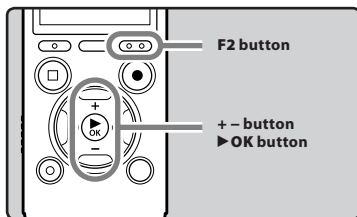

Only MP3 files and PCM files recorded on this recorder can be divided.

1 Stop playback at the divide position.

- While the recorder is during playback mode, press and hold the ►►► or ◀◀◀ button to fast-forward or rewind.
- It is useful to set index marks on marking in advance at the divide position.

2 Select [File Divide] from the menu on the [File Menu].

- For details on how to enter the menu settings, see "Menu setting method" (P.51).



3 Press the + button to select [Start].



4 Press the ► OK button.

- [Dividing!] will appear and file dividing will start.
- File dividing is completed when [File divide completed] appears.

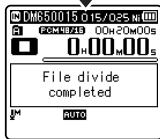
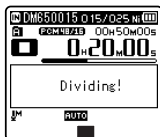

5 Press the F2 (EXIT) button to close the menu screen.

Notes

- File dividing can be performed only when the file list is displayed.
- The recorder cannot divide files when the number of files in the folder exceeds 199.
- Locked files cannot be divided (P.53).
- After splitting the file, the front part of the file will be renamed as [File name_1.MP3] and the latter part of the file will be named as [File name_2.MP3].

- If a file has an extremely short recording time, it may not be divided even if it is a MP3 file or PCM file.
- Do not remove the battery while dividing a file. This may damage the data.

Timer recording [Timer Rec]

Timer recording is the function to execute a recording at a set time. You can program up to three desired settings (Preset 1-3) ([On/Off], [Day], [Time], [Rec Mode], [Folder], and [Mic Sense]).

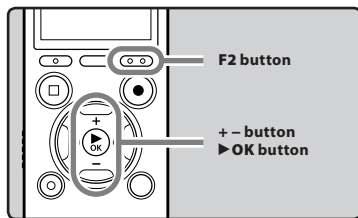

4

Menu setting method

1 Select [Timer Rec] from the menu on the [Rec Menu].

- For details on how to enter the menu settings, see "Menu setting method" (P.51).

2 Press the + or – button to select a preset number.



3 Press the ►OK button.

4 Press the + or – button to select the item to set.



- Select items you want to set from among [On/Off], [Day], [Time], [Rec Mode], [Folder], and [Mic Sense].

5 Press the ►OK button to move to the respective setting.

[On/Off] setting:

- 1 Press the + or – button to select between [On] and [Off].
[On]: Setting will be applied.
[Off]: Setting will not be applied.
- 2 Press the ►OK button to exit [On/Off] selection.

[Day] setting:

- 1 Press the + or – button to select from [One Time], [Everyday], and [Every Week].
[One Time]: Records only once at the specified time.
[Everyday]: Records every day at the specified time.
[Every Week]: Make a recording at a set time on a specified day of the week. Select [Every Week] and press the ►OK button to move to the selection of [Day]. Press the + or – button to select a day of the week.
- 2 Press the ►OK button to exit [Day] selection.

[Time] setting:

- Press the ►► or ◀◀ button to select "Hour" and "Minute" in the [Start Time] and "Hour" and "Minute" in the [Stop Time].
- Press the + or – button to set.
- Press the ►OK button to exit [Time] selection.

[Rec Mode] setting:

Regardless of the regular [Rec Mode] (P.54), timer recording will start in a set recording mode.

- Press the + or – button to select a recording mode.
- Press the ►OK button.
- Press the + or – button to select a recording rate.
- Press the ►OK button to exit [Rec Mode] selection.

[Folder] setting:

- Press the + or – button to select the destination to save to (Memory).
- Press the ►OK button to move to the [Folder] setting.
- Press the + or – button to select the destination to save to (Folder).
- Press the ►OK button to exit [Folder] setting selection.

[Mic Sense] setting:

Regardless of the recorder's microphone sensitivity setting (P.53), timer recording will start at a set microphone sensitivity.

- Press the + or – button to select from [High], [Middle], and [Low].
- Press the ►OK button to exit [Mic Sense] selection.

6 Press + or – button to select [Finish].**7 Press the ►OK button to complete the setting.**

When setting to [ON]

- Programmed settings will be applied and the display will return to the preset number selection menu.
 - To set other preset numbers, repeat the above mentioned procedure.
 - When the ►► button is pressed in the Select in Advance Menu, the settings selected can be confirmed.
- 8 Press the F2 (EXIT) button to close the menu screen.**
- The [⊗] will appear on the display.

Notes

- If the recorder is in use at the preset start time, the timer recording will start directly after stopping the recorder.
- Even if the power is turned off or the recorder is put on Hold, timer recording will start at a specified time.
- If three timer recordings have the same starting times, [Preset 1] has the highest priority and [Preset 3] has the lowest.
- If the starting time for timer recording and alarm playback (P.72) is set for the same time, timer recording will have priority.

- If the batteries run out while recording based on the timer setting, the recorder will stop recording. Check the battery power before starting the timer recording.
- If the [Time & Date] is not correct, timer recording cannot be set at the specified time, so make sure the [Time & Date] is correct before setting timer recording. If it is not correct, reset [Time & Date] (P.23).
- The recorder will record in the built-in memory [Folder A] when the microSD card is selected as the recording destination and the microSD card is not inserted during Timer Recording.

4

Alarm playback function [Alarm]

The alarm playback function can be set to play a selected file at a pre-set time.

You can program up to three desired settings (Preset 1-3) ([On/Off], [Day], [Start Time], [Volume], [Alarm Sound] and [Playback File]).

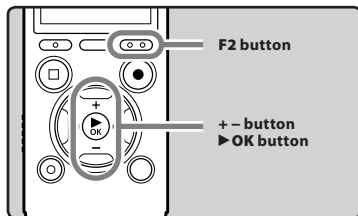

- 1 Select [Alarm] from the menu on the [Play Menu].**
 - For details on how to enter the menu settings, see "Menu setting method" (P.51).
- 2 Press the + or – button to select a preset number.**

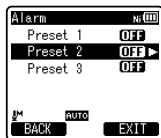

- 3 Press the ▶OK button.**

- 4 Press the + or – button to select the item to set.



- Select items you want to set from among [On/Off] [Day] [Start Time] [Volume] [Alarm Sound] [Playback File].

- 5 Press the ►OK button to move to the respective setting.

[On/Off] setting:

- Press the + or – button to select between [On] and [Off].
[On]: Setting will be applied.
[Off]: Setting will not be applied.
- Press the ►OK button to exit [On/Off] selection.

[Day] setting:

- Press the + or – button to select from [One Time], [Everyday], and [Every Week].
[One Time]: Alarm Playback will be performed only once at the specified time.
[Everyday]: Alarm Playback will be performed at the specified time every day.
[Every Week]: Make a Alarm Playback at a set time on a specified day of the week.
Select [Every Week] and press the ►OK button to move to the selection of [Day]. Press the + or – button to select a day of the week.
- Press the ►OK button to exit [Day] selection.

[Start Time] setting:

- Press the ►► or ◀◀ button to select "Hour" and "Minute" in the [Start Time].
- Press the + or – button to set.
- Press the ►OK button to exit [Start Time] selection.

[Volume] setting:

- Press the + or – button to adjust the volume. Press the F1 button to check the volume.
- Press the ►OK button to exit [Volume] selection.

[Alarm Sound] setting:

- Press the + or – button to select an alarm sound from among [Alarm1], [Alarm2] and [Alarm3]. Press the F1 button to check the alarm sound.
- Press the ►OK button to exit [Alarm Sound] selection.

[Playback File] setting:

- Press the + or – button to select from [No File Play], [File Select].
[No File Play]: Sounds alarm only.
[File Select]: Plays back a selected file after the alarm.
 - When [File Select] is selected and the ►OK button is pressed, the recorder will move to the [Memory Select] setting.
 - Select the memory with an alarm playback file using the + or – button and press the ►OK button. The recorder will move to the folder settings with the file with alarm playback.

- Select the folder using the + or – buttons and press the ►OK button to move to file selection. Use the + or – button to select the file in the same way.

② Press the ►OK button to exit [Playback File] selection.

6 Press + or – button to select [Finish].



7 Press the ►OK button to complete the setting.

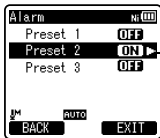

When setting to [ON]

- Programmed settings will be applied and the display will return to the preset number selection menu.
- To set other preset numbers, repeat the above mentioned procedure.
- When the ► button is pressed in the Select in Advance Menu, the settings selected can be confirmed.

8 Press the F2 (EXIT) button to close the menu screen.

- The [Ⓜ] will appear on the display.

Notes

- If [Everyday] is selected, the alarm will sound at the scheduled time every day unless alarm playback is canceled.
- The alarm will sound for five minutes and then stop. In such a case, even if a file is selected for Alarm Playback, it will not be automatically played.
- If three alarm playback have the same starting times, [Preset 1] has the highest priority and [Preset 3] has the lowest.
- If the recorder is in use or if operations are being performed at the scheduled time, the Alarm Playback function will not be available.
- The alarm will sound at the scheduled time even if the power is turned off or the recorder is set to Hold mode. The recorder begins to play the selected file when you press any button, and stops playing when you press the STOP (■) button.
- If the selected file is moved, erased or the microSD card removed, file playback will not be performed and only the alarm will sound.
- If the starting times for timer recording and alarm playback are set for the same time, timer recording will have priority (Ⓜ P.70).
- If the recorder is formatted (Ⓜ P.77), the alarm sound data will also be erased. The alarm playback function is available but the alarm sounds [Alarm 1] [Alarm 2] [Alarm 3] in [Alarm Sound] will all have the same sound. At this stage, the alarm sounds will be different from the pre-set ones. If you want to recover the alarm sound data, connect to the PC and copy the default sound data to the recorder by using the supplied "Olympus Sonority" (Ⓜ P.86).

Guidance [Voice Guide] (DM-670 only)

This feature gives audio announcements of recorder operating conditions. Adjust the speed and the volume of guidance announcements.

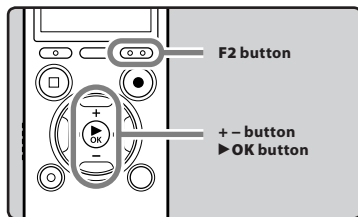

1 Select [Voice Guide] from the menu in [LCD/Sound Menu].

- For details on how to enter the menu settings, see "Menu setting method" (P.51).

2 Press the + or – button to select the item to set.

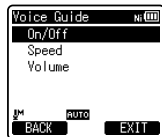

- Select items you want to set from among [On/Off], [Speed] and [Volume].

3 Press the ►OK button to move to the respective setting.

[On/Off] setting:

- Press the + or – button to select between [On] and [Off].
[On]: Guidance will be provided.
[Off]: Guidance will be canceled.
- Press the ►OK button to exit [On/Off] selection.

[Speed] setting:

- Press the + or – button to select from [Speed5], [Speed4], [Speed3], [Speed2], and [Speed1].
- Press the ►OK button to exit [Speed] selection.

[Volume] setting:

- Press the + or – button to select from [Volume5], [Volume4], [Volume3], [Volume2], and [Volume1].
- Press the ►OK button to exit [Volume] selection.

4 Press the F2 (EXIT) button to close the menu screen.

Notes

- The starting tune/closing tune when the power is turned On/Off (P.20) can be canceled if you set the guidance to [Off].
- If you format the recorder (P.77), voice guide data will be erased as well. If you want to recover the voice guide data, connect to a PC and copy the guide data to the recorder by using the supplied "Olympus Sonority" (P.86).
- Set the volume of the starting tune/closing tune at the guidance [Volume] setting.
- The [Speed] setting in the [Voice Guide] settings is disabled during file playback.

Changing the USB class

[USB Settings]

Besides setting to [PC] (Connect to PC to transfer files) or [AC Adapter] (Connect to AC adapter to recharge the battery), you can switch the USB class according to your usage.

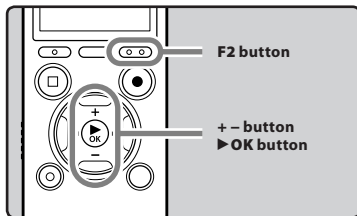

1 Select [USB Settings] from the menu on the [Device Menu].

- For details on how to enter the menu settings, see "Menu setting method" (P.51).

2 Press the + or – button to select [USB Connect] or [USB Class].



[USB Connect]: Setting for connecting to the PC.

[USB Class]: Setting for USB class.

3 Press the ▶ OK button.

- If you select [USB Class], proceed to the operation of Step 6.

When [USB Connect] is selected:

4 Press the + or – button to change the setting.

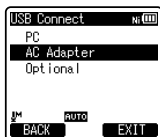

[PC]: Setting for when the recorder is connected to the PC and used as a storage device or composite device. Connected as storage or composite.

[AC Adapter]: Setting for when the recorder is connected to the PC for charging or to the AC Adapter (A514) (optional).

[Optional]: Setting to confirm the connection method each time a USB connection is made.

5 Press the ▶ OK button to complete the setting.

- If you select [USB Connect], proceed to the operation of Step 8.

When [USB Class] is selected:

6 Press the + or – button to change the setting.

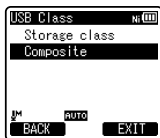

[Storage class]: Recognized as an external memory device from the PC.

[Composite]: Setting when connected to the PC and used as an external memory device, USB speaker or microphone.

- 7 Press the ► **OK** button to complete the setting.
- 8 Press the **F2 (EXIT)** button to close the menu screen.

Notes

- When you first connect the recorder to your PC as an external storage device, the driver for the recorder will be automatically installed in your PC.
- The PC cannot recognize when the recorder is connected to the PC when setting for the [**USB Connect**] is set to [**AC Adapter**].
- When the recorder is not recognized by the PC as an external storage device, change the [**USB Class**] setting to [**Storage class**].

Formatting the recorder [Format]

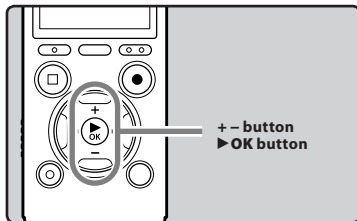

- !** If you format the recorder, all files will be removed and all function settings will return to defaults except date and time settings. Transfer any important files to a computer before formatting the recorder.

- 1 Select [**Format**] from the menu on the [**Device Menu**].
 - For details on how to enter the menu settings, see "Menu setting method" (P.51).
- 2 Press the + or – button to select the recording media to format.



- 3 Press the ► **OK** button.

4 Press the + button to select [Start].



5 Press the ► OK button.

- After [Data will be cleared] message is on for two seconds, [Start] and [Cancel] will turn on.



6 Press the + button again to select [Start].

7 Press the ► OK button.

- Formatting begins and [Format !] flashes on the display.



- [Format Done] appears when formatting ends.

Notes

- Never format the recorder from a PC.
- When the recorder is formatted, all the saved data, including locked files and read-only files, are erased.
- After formatting, recorded voice file names may start from [0001].
- To restore the function's settings to their initial values, use [Reset Settings] (P.64).
- When a microSD card is inserted in the recorder, be sure to confirm the recording media as either [Built-in Memory] or [microSD Card] so that there is no mistake (P.64).

- It may take over 10 seconds to complete processing. Never perform operations such as the following while processing, as they may damage the data. In addition, replace the battery with a new one in order to ensure that the battery will not run out while processing.
 - ① Disconnecting the AC Adapter while processing.
 - ② Removing the battery while processing.
 - ③ Remove the microSD card during processing when **[microSD Card]** is being used as the recording media.
- Formatting on the recorder will be Quick Format. If you format the microSD card, information of file management is refreshed and the data inside the microSD card is not deleted completely. When handing over and disposing the microSD card, be careful about the data leakage from the microSD card. We recommend the microSD card to be destroyed when you dispose the microSD card.
- If the recorder is formatted (☞ P.77), the starting/closing tune data will also be erased, and the starting tune and closing tune will not be played. If you want to recover the starting/closing tune data, connect to the PC and copy the default sound data to the recorder by using the supplied "Olympus Sonority" (☞ P.86).
- If the recorder is formatted (☞ P.77), the alarm sound data will also be erased. The alarm playback function is available but the alarm sounds **[Alarm 1]** **[Alarm 2]** **[Alarm 3]** in **[Alarm Sound]** will all have the same sound. At this stage, the alarm sounds will be different from the pre-set ones. If you want to recover the alarm sound data, connect to the PC and copy the default sound data to the recorder by using the supplied "Olympus Sonority" (☞ P.86).

For DM-670:

- If you format the recorder (☞ P.77), voice guide data will be erased as well. If you want to recover the voice guide data, connect to a PC and copy the guide data to the recorder by using the supplied "Olympus Sonority" (☞ P.86).

Using the recorder on your PC

By being connected to a PC, the recorder enables you to do the following:

- Voice files recorded on the recorder can be played and managed on the PC using the “Olympus Sonority”.

If an upgrade (Optional) to the “Olympus Sonority Plus” is executed or a Music Editing Plug-in is added (Optional), various additional functions can be utilized (☞ P.87).

- You can transfer files recorded with this recorder to a computer, play them back, and manage them by using Windows Media Player or iTunes.
- In addition to its uses as a voice recorder and a music player, this recorder can also be used as external memory for a computer by storing data from a computer and reading it back out (☞ P.93).

Operating environment

Windows

Operating System:

Microsoft® Windows® XP Service Pack 2, 3
Microsoft® Windows® XP Professional x64 Edition Service Pack 2
Microsoft® Windows Vista® Service Pack 1, 2 (32bit/64bit)
Microsoft® Windows® 7 (32bit/64bit)

CPU:

32 bits (x86) of 1GHz or above or 64 bits (x64) processor

RAM:

512 MB or more

Hard drive space:

300 MB or more

Drive:

CD-ROM, CD-R, CD-RW, DVD-ROM drive

Browser:

Microsoft Internet Explorer 6.0 or later

Display:

1024 x 768 pixels or more, 65,536 colors or more (16,770,000 colors or more is recommended)

USB port:

One or more free ports

Others:

- Audio device
- Environment where the Internet can be utilized.

Notes

- The support service will not cover if your PC has been updated from Windows 95/98/Me/2000 to Windows XP/Vista/7.
- Any failure on a self-modified PC will not be covered under the operational warranty.

Macintosh

Operating System:

Mac OS X 10.4.11 - 10.6

CPU:

PowerPC® G5 or Intel Multicore Processor
1.5 GHz or above

RAM:

512 MB or more

Hard drive space:

300 MB or more

Drive:

CD-ROM, CD-R, CD-RW, DVD-ROM drive

Browser:

Macintosh Safari 2.0 or later

Display:

1024 x 768 pixels or more, 32,000 colors
or more (16,770,000 colors or more is
recommended)

USB port:

One or more free ports

Others:

- Audio device
- Environment where the Internet can be utilized.

Precautions on using the recorder connected to a PC

- When you are downloading a file from the recorder or uploading a file to the recorder, do not remove the USB cable even if the screen is indicating you can. Data is still being transferred while the LED indicator light is blinking. When removing the USB cable, be sure to follow the description in **☞** P.91. If the USB cable is removed before the drive is stopped, data may not be successfully transferred.
- On a PC, do not format the drive of the recorder. Initialization is not successfully achieved on a PC. For initialization, follow the instructions in the **[Format]** display of the recorder (**☞** P.77).
- Folder (directory) names displayed by file management tools such as Explorer in Microsoft Windows and Finder in Macintosh are different from the folder names that can be set with the recorder or the "Olympus Sonority".
- If folders or files stored on the recorder are moved or renamed by using a file management tool in Windows or Macintosh, the order of files may be changed or files may become unrecognizable.
- Data can be written or uploaded to the recorder even though the attribute of the recorder drive is shown as Read-only by the operating system of the PC.
- As the noise may cause adverse effects on electronics devices nearby the recorder, unplug the external microphone and earphone when you connect the recorder to a PC.

Using Olympus Sonority

Functions available in the Olympus Sonority

Various functions such as file management and editing are installed in the “Olympus Sonority”. For information on operating procedures and detailed settings, please refer to the respective items on online help (☞ P.89).

Waveform editing function:

Using the Waveform Editing Function Tab, you can easily process the voice data. In the Waveform Editing Mode, you can also delete unnecessary parts, paste and re-save the data.

One-touch effect function:

Using the One-touch Effect Function, you can easily apply special effects to the voice file and carry out noise reduction in any specified area.

Changing the User ID:

The user ID will be automatically given to files that are recorded with the recorder.

Changing a folder name:

You can change a folder name. A folder name can be up to 12 characters long and cannot use \ / : * ? " < > | .
If you change the folder name using an OS in a language not supported by this recorder, the words may become garbled.

* A function to convert PCM and WMA files to MP3 format is available by upgrading to the “Olympus Sonority Plus” (☞ P.87).

Changing the file format to other format: *

The current file format can be changed to other formats.

Joining files: *

In “Olympus Sonority”, designated multiple voice files can be joined and one voice file can be created.

Splitting files: *

One designated voice file can be split into the two files in “Olympus Sonority”.

Installing software

Before you connect the recorder to your PC and use it, you must first install the “Olympus Sonority” software from the included Software CD-ROM.

Be sure to confirm the following before installation:

- Exit all running applications.
- You need to log on as an Administrator.

Windows

- 1 Insert “Olympus Sonority” into the CD-ROM drive.**
 - The installation program will start automatically. Once the program starts, jump to step 4. If it does not, follow the procedures in steps 2 and 3.
- 2 Open contents in the CD-ROM with [Explorer].**
- 3 Double-click [Setup] in the CD-ROM.**
- 4 When the “Olympus Sonority” launch screen is displayed, click the desired language to select it.**
- 5 When [Olympus Sonority Setup] is clicked, the Installer Opening display will start up. Follow the Installer Wizard instructions.**
- 6 Confirm your acceptance of the terms of the Licensing Agreement.**
 - You must accept the terms of the Licensing Agreement to install “Olympus Sonority”. After checking the [Agree] box, click [Next].
- 7 [Registration of User Registration Information]**
 - Please enter your name, company name and serial number which is listed on the separate sheet. Click [Next] after entering.
- 8 [Select Setup Type]**
 - The installation destination can be changed. Click [Next] if you do not want to change (Select [Custom] if you want to change).
- 9 [Start Installation]**
 - Click [Install] to start installing. Do not carry out other operations before the installation is completed and the [Complete] display is displayed.
- 10 [Installation Complete]**
 - When the installation is completed, the completed [Install Shield] display will be displayed.

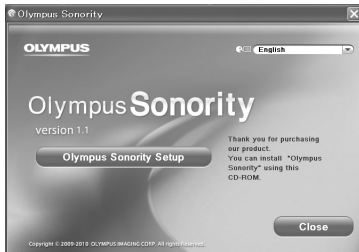

Macintosh

1 Insert “Olympus Sonority” into the CD-ROM drive.

- Proceed to step 3 when the content of CD-ROM is displayed, and go to steps 2 and 3 when nothing is displayed.

2 Open contents in the CD-ROM with [Finder].**3** Double-click [Setup] in the CD-ROM.**4** When the “Olympus Sonority” launch display is displayed, click the desired language to select it.**5** When [Olympus Sonority Setup] is clicked, the installer opening display will start up. Follow the Installer wizard instructions.**6** Confirm your acceptance of the terms of the licensing agreement.

- You must accept the terms of the licensing agreement to install “Olympus Sonority”. After checking the [Agree] box, click [Next].

7 [Changing the Installation Destination]

- The installation destination can be changed. Click [Next] if you do not want to change (Select [Change Installation Destination] if you want to change).

8 [Start Installation]

- When the installation is completed, the completed [Installer] display will be displayed.
- After starting up the “Olympus Sonority”, the serial number entry dialog box will appear. Enter the serial number which is listed on the separate sheet. After entering, click [OK] and the “Olympus Sonority” will start up.

Uninstalling software

To uninstall any of the software component of the “Olympus Sonority” software installed on your PC, follow the steps below.

Windows

- 1 Exit “Olympus Sonority”.
- 2 Select **[Control Panel]** from **[Start]** menu.
- 3 Click **[Add/Remove programs]** in the control panel window.
- 4 When the installed application list is displayed, select **[Olympus Sonority]**.
- 5 Click **[Change/Remove]**.
- 6 **Confirmation of deleting the file.**
 - Click the **[OK]** button to start uninstalling. An additional message may appear, if so, read it carefully and follow the instructions given.
- 7 When the **[Maintenance Complete]** display is displayed, click **[Finish]** to complete uninstalling.

Files left after uninstallation

The voice files you made are stored in the **[MESSAGE]** folder. If you don't need them, delete them.

You can confirm the location of the **[MESSAGE]** folder by clicking **[Options]** in the **[Tools]** menu before uninstalling.

Macintosh

- 1 Exit “Olympus Sonority”.
- 2 Open **[Finder]** and double-click the **[SonorityUninstaller.pkg]** in the application folder.
- 3 The Uninstaller will start up. Follow the wizard instructions.
- 4 When the administrator password is asked, enter the password then click **[OK]**.
- 5 Uninstall will start and when **[Successful]** is displayed, click **[Close]**.

Copying data from the Olympus Sonority software

If you format the recorder and erase data by mistake, you can copy the default sound data from “Olympus Sonority” to the recorder.

For DM-670:

Make sure that the recorder’s voice guide is set to [On].

- If the recorder’s voice guide is set to [Off] (☞ P.75) the voice guide data cannot be copied.

1 Connect the recorder to a PC.

- For how to connect to a computer, see “Connecting to your PC” (☞ P.90).

2 Start “Olympus Sonority”.

For DM-670:

- If the recorder does not have voice guide data, the [File Transfer] dialog will appear.

For DM-650:

- Copy of the default sound data will start automatically.

3 Copy the default sound data.

- If you click the [OK] button in the [File Transfer] dialog, it will start copying voice guide data, and a window indicating copying progress will appear.

4 Copying of the default sound data will be completed.

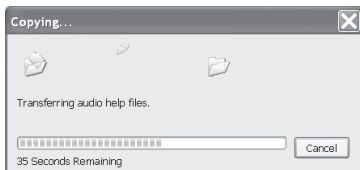
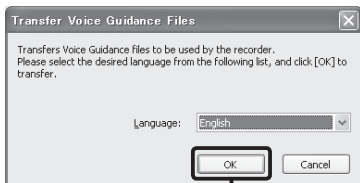

Notes

- NEVER disconnect the USB cable while the LED indicator light is flashing. If you do, the data will be destroyed.

For DM-670:

- The alarm sound (☞ P.72), the Starting tune that plays when the recorder is starting up, and the Closing tune that plays when the recorder is turning off (☞ P.20), will be copied together with the voice guide data.

Upgrade function

The “Olympus Sonority” can be upgraded to the Plus Version (Optional) to expand and improve its functions. In addition, in the “Olympus Sonority Plus”, you can purchase a Music Editing Plug-in to enjoy high-quality effect editing. To add a Music Editing Plug-in, you will need to upgrade the “Olympus Sonority Plus”.

Purchase and upgrade

How to purchase “Olympus Sonority Plus” and upgrade from “Olympus Sonority” is shown in the following procedures.

- 1 Start the “Olympus Sonority”.**
- 2 Select [Purchase Olympus Sonority Plus] in the [Help] Menu or click the  button in the Tool Bar.**
 - The web browser will start and the purchase site of the “Olympus Sonority Plus” will be displayed. Please operate according to guidance on the screen. When the purchase procedure is completed, the Upgrade Key will be issued by mail.
- 3 Select [Upgrade to Olympus Sonority Plus] from the [Help] menu.**
 - The [Upgrade to Olympus Sonority Plus] dialog will be displayed.
- 4 In the [Upgrade to Olympus Sonority Plus] dialog, enter the Upgrade Key of your purchase, and click the [OK] button.**
 - When starting the application next time, “Olympus Sonority” will be upgraded to “Olympus Sonority Plus”.

Upgrading to Olympus Sonority Plus

Click the root of the Main Tree view, [**Olympus Sonority**], in the Browse Screen to display the Information Screen. You can confirm that the upgrade key is registered. In addition, when [**Version Information**] in the [**Help**] Menu is selected, the upgrade key registered in “Olympus Sonority Plus” will be displayed. The Music Editing Plug-in includes more than 20 types of effect functions and spectrum analyzer functions. For details, please refer to the Online Help (® P.89).

Notes

- To purchase the Upgrade Key, it requires an environment where the Internet can be utilized.
- Please refer to the details in the website regarding the purchase of the Upgrade Key.

Functions available in the Olympus Sonority Plus:

Besides the usual functions, the “Olympus Sonority Plus” also includes various functions to edit music files. For information on operating procedures and detailed settings, please refer to the Online Help (P.89).

MP3 editing:

MP3 file and tag editing and writing function.

Creating music CD:

Function to create music CD from voice files registered in the CD writable folder.

Recorder menu setting:

Function for settings in this recorder (detailed settings such as alarm setting, timer recording, etc.).

Functions available with the music editing plug-in:

By purchasing a music editing plug-in, you can add high-quality functions to expand the music editing range in the “Olympus Sonority Plus”. For detailed purchasing method and operating procedures, please refer to the Online Help (P.89).

Effect functions:

You can use more than 20 high-quality effect functions to edit your music files.

Spectrum analyzer:

The frequency spectrum of the sound file being played will be displayed on the waveform editing screen in real time.

Besides unrestricted track editing:

It also removes the restriction on the number of tracks that can be edited.

Using online help

To open Online Help:

- While “Olympus Sorority” is running, select [Contents] from the [Olympus Sorority Help] menu.

■ Search by contents:

1 Once the Online Help display appears, click the Contents tab.

2 Double-click the  icon of the desired topic heading.

3 Double-click the  icon of the desired topic.

- An explanation of the topic is displayed.



■ Search by keyword:

1 Open Online Help and click the [Index] item.

- Matching keywords are located automatically.

2 Click keyword.

- An explanation of the topic is displayed.



Note

- For more information on menus and operations, refer to Online Help. You will be able to use Online Help after “Olympus Sorority” is installed.

Connecting to your PC



Before you connect the recorder to your PC and use it, you must first install the “**Olympus Sonority**” software from the included Software CD-ROM (P.83).

- 1 Boot the PC.**
- 2 Connect the USB cable to the USB port of the PC.**

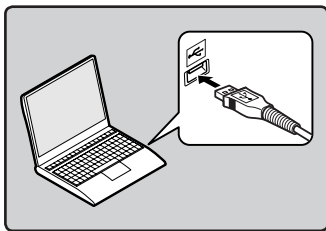

- 3 While the recorder is during stop mode or turned off, connect the USB cable to the connecting terminal on the bottom of the recorder.**

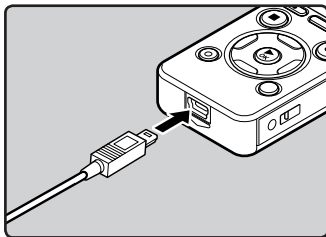

- **[Remote (Storage)]** is displayed on the recorder if the USB cable is connected.
- When the recorder is using the USB connection setting, it will not be connected to the PC when **[AC Adapter]** is selected. Select **[PC]** in the USB connection setting (P.76).

Windows:

When you connect the recorder to Windows and open **[My Computer]**, it will be recognized by the drive name of the product name. Inserting a microSD card will allow you to use it as **[Removable Disk]**.

Macintosh:

When you connect the recorder to Mac OS, it will be recognized by the drive name of the product name on the desktop. If a microSD card is inserted, **[Untitled]** will be displayed.

Notes

- Before connecting the USB cable, exit HOLD mode.
- Refer to the user's manual for your PC regarding the USB port on your PC.
- Be sure to push the cable connector all the way in. Otherwise, the recorder may not operate properly.
- When connecting the recorder through an USB hub the operation may become unstable. In such cases, refrain from using a USB hub.
- Be sure to use the included dedicated USB cable. If any other company's cable is used, it may lead to malfunction of the recorder. Also, never use this dedicated cable with any other company's products.

Disconnecting from your PC

Windows

- 1 Click [] on the task bar located at the lower-right corner of the screen. Click [Safely remove USB Mass Storage Device].



- The drive letter will differ depending on the PC being used.
- When the window indicating that it is safe to remove hardware window appears, close the window.

- 2 Confirm that the recorder LED indicator light is gone before disconnecting the USB cable.

Macintosh

- 1 Drag and drop the recorder's drive icon for this recorder displayed on the desktop to the Recycle Bin icon.



- 2 Confirm that the recorder LED indicator light is gone before disconnecting the USB cable.

Note

- NEVER disconnect the USB cable while the LED indicator light is flashing. If you do, the data will be destroyed.

Transfer the voice files to your PC

The 5 voice folders of this recorder are named as [Folder A], [Folder B], [Folder C], [Folder D] and [Folder E]. The recorded voice files are saved in these folders.

Windows

- 1 **Connect the recorder to your PC** (P.90).
- 2 **Open the Explorer window.**
 - When you connect the recorder to Windows and open [My Computer], it will be recognized by the drive name of the product name. Inserting a microSD card will allow you to use it as [Removable Disk].
- 3 **Open the product name folder.**
- 4 **Copy the data.**
- 5 **Disconnect the recorder from the PC** (P.91).

Macintosh

- 1 **Connect the recorder to your PC** (P.90).
 - When you connect the recorder to Mac OS, it will be recognized by the drive name of the product name on the desktop. If a microSD card is inserted, [Untitled] will be displayed.
- 2 **Double-click the product name icon on the desktop.**
- 3 **Copy the data.**
- 4 **Disconnect the recorder from the PC** (P.91).

Drive names and folder names when a PC is connected:

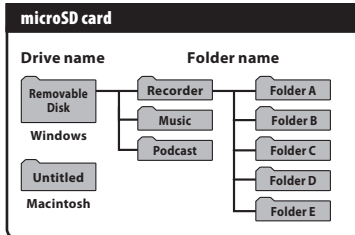
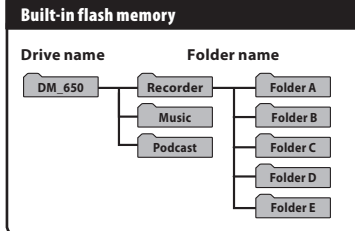

Notes

- While transmitting data, [Busy] is displayed, and the LED indicator light flashes. NEVER disconnect the USB cable while the LED indicator light is flashing. If you do, the data will be destroyed.
- In the Mac OS operational environment, WMA format files cannot be played back.

Usage as external memory of the PC

In addition to its uses as a voice recorder and a music player, this recorder can also be used as external memory for a computer by storing data from a computer and reading it back out. With the recorder connected to your PC, you can download data from the memory to your PC and upload data stored on your PC to the memory.

Windows

- 1 Connect the recorder to your PC** (P.90).
- 2 Open the Explorer window.**
 - When you open [My Computer], it will be recognized by the drive name of the product name.
- 3 Open the product name folder.**
- 4 Copy the data.**
- 5 Disconnect the recorder from the PC** (P.91).

Macintosh

- 1 Connect the recorder to your PC** (P.90).
 - When you connect the recorder to a Mac OS, it will be recognized by the drive name of the product name on the desktop.
- 2 Double-click the product name icon on the desktop.**
- 3 Copy the data.**
- 4 Disconnect the recorder from the PC** (P.91).

Note

- While transmitting data, [Busy] is displayed, and the LED indicator light flashes. NEVER disconnect the USB cable while the LED indicator light is flashing. If you do, the data will be destroyed.

Using Audible content

Loading Audible content

Use the AudibleManager to load Audible content onto the recorder. Playback, management, and transfer of Audible content to the recorder can be done using the AudibleManager.

■ Installing AudibleManager:

When AudibleManager is not installed on a computer, install the AudibleManager according to the procedure described below.

Windows

- 1 Access one of Audible web sites from the web browser and download the AudibleManager.**
<http://www.audible.com/> (United States)
<http://www.audible.co.uk> (United Kingdom)
<http://www.audible.fr> (France)
<http://www.audible.de> (Germany)

- 2 Start up the downloaded executable file.**

- The AudibleManager Setup screen will be displayed. Select the name of the device in use (OLYMPUS DM-670, DM-650) and click the **[Install]** button.

- 3 When the [Audible Manager License Agreement] is displayed, click the [I Accept] button.**

- 4 Installation starts.**

- Wait until process has been completed. Once the installation has been completed AudibleManager starts up automatically.

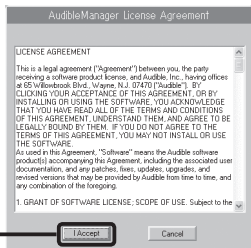
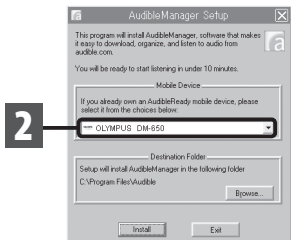

■ Adding device to AudibleManager:

If AudibleManager has already been installed, add a device in order to handle the recorder in the AudibleManager. Follow the procedure described below.

1 Select [Add New Device] in the [Devices] menu.



2 When the dialog box is displayed, verify the internet connection and click the [Yes] button.



3 When the dialog box is displayed, check the name of the device in use (DM-670, DM-650) and click the [OK] button.

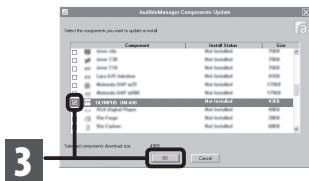

4 Installation starts.

- Wait until the process has been completed. Once the installation has been completed, AudibleManager restarts. Verify that the device in use has been added to the [Mobile Devices] menu.

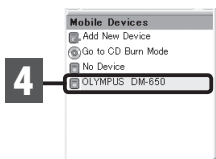

■ Purchasing Audible content:

Audible content can be purchased from the Audible web site. Access to the Audible web site using web browser and downloaded the content by following the purchase procedures described on the web site.

With the existing setting, content will be downloaded into AudibleManager's Library folder. When download has been completed, the AudibleManager starts up and purchased content is displayed on the contents list in the Library.

Transferring Audible content

Audible content can be transferred into the **[Audible]** folder on the recorder by following the procedure described below.

Windows

- 1 **Connect the recorder to a computer.**
- 2 **Select [Library] in the [Audible Folders] tree listing.**
 - A list of content stored in the **[Library]** is displayed on the right side.
- 3 **Select the content to be transferred to the recorder and click the [Add to Device] button.**
- 4 **When the [Activate Your Device] entry screen is displayed, enter the user name and password for Audible and click the [OK] button.**
- 5 **The transfer begins.**
 - Wait until the transfer of the content has been completed. When it has been completed, the transferred content is displayed in the contents listing of the device. Also, the transferred content is displayed in the Library.

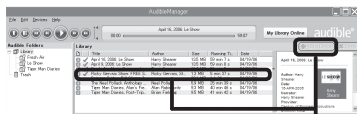

3



4



5

Notes

- When a content file is transferred to the recorder, a **[.pos]** file will be automatically created for each content file in the Audible folder.
- When the **[*.pos]** file is deleted, using Explorer, the stored Playback Position will be deleted. The next time the file is selected, playback starts from the beginning of the file.
- When a content file is transferred to the recorder, a system file will be created as a hidden file inside the Audible folder. When this file is deleted using Explorer, it is no longer possible to play back the Audible content.



Enjoy Audible content with the recorder

Audible content that has been transferred into the **[Audible]** folder on the recorder from a computer can be enjoyed with an exclusive mode optimally suited for the operation of Audible content.

■ Audible mode:

When you select the **[Audible]** folder in the **[Music]** folder, the recorder automatically switches to the Audible mode. The Audible mode is an exclusive mode for enjoying Audible content (Mode 3 and Mode 4 formats*) transferred from a computer. The operating method for Audible mode differs from when other folders on the recorder are selected (Normal mode). See the **“Operating the Recorder in Audible Mode”** (P.99) for details.

File display screen in Audible mode:

In the Audible mode, **[Play Mode]** (P.61) becomes the **[File]** setting regardless of the menu settings and the recorder stops after playing back one file. In addition, icons ( , ) which indicate Audible files are also displayed on the File display screen.



See **“Selecting the folders and files”** (P.30) for details relating to the selection method of folders and files.

Ⓐ Audible file indicator



Re-playable Audible files:

Files in Mode 3 and Mode 4 formats can be played back in the Audible mode. Only those Audible files that have an **[.aa]** extension are displayed in the Audible mode (in the Audible folder on the recorder).

Re-playable Audible files formats*	
Mode	Codec
3()	ACELP (16kbps)
4()	MP3 (32kbps)

■ Playback position and section:

In the Audible mode, the starting position can be moved easily by referring to the [Playback Position] which is the positional information stored from previous stops for each file, and by referring to "Section" where the content distributor has preset the position.

Playback position:

The Playback Position (positional information) is stored in the [.pos] file, which is created automatically by the recorder for each Audible content file ([.aa] file).

The Playback Position is initially located at the beginning of the file, and the stop position will be updated by playback or the use of S. Play (slow playback)/F. Play (fast playback).

Press the ►► or ◀◀ button to move the stop position while the recorder is stopped. The Playback Position will not be updated.

Section:

Up to 100 divisions (chapters of a story or segments of news) are set arbitrarily for each file by the distributor of the content.

Notes

- When a content file is transferred to the recorder, a [.pos] file will be automatically created for each content file in the Audible folder.
- You can not set the Index marks or the Temp marks in the Audible mode.
- When the [* .pos] file is deleted, using Explorer, the stored Playback Position will be deleted. The next time the file is selected, playback starts from the beginning of the file.
- When a content file is transferred to the recorder, a system file will be created as a hidden file inside the Audible folder. When this file is deleted using Explorer, it is no longer possible to playback the Audible content.

■ Operating the Recorder in Audible mode:

The operating method of the recorder is different in the Audible mode when the [Audible] folder or Audible file is selected, then while in the Normal mode.

Forwarding

Press and hold the ►►| button while the recorder is stopped.

- ↳ When the button is released fast forwarding stops. The Playback Position is not updated. When the ►OK button is pressed playback resumes from that position.

Press and hold the ►►| button while playing a file.

- ↳ When you release the ►►| button the recorder will resume normal playback.
- If the starting position of a section (Ⓢ P.98) and the playback position are in the middle of a file, the recorder stops at those positions.
- When the ►►| button is held down while the recorder is stopped, the recorder moves to the end of the file and then stops.
If the ►►| button is still held down, the recorder moves to the next file and continues fast forwarding from the beginning of the file. After fast forward reaches the end of the last file, the recorder stops at the beginning of the last file.
- When the ►►| button is held down during playback and the end of the file is reached, the recorder goes back to the beginning of the file then stops.

Rewinding

Press and hold the |◀◀ button while the recorder is stopped.

- ↳ When the button is released fast rewinding stops. The Playback Position is not updated. When the ►OK button is pressed, playback resumes from that position.

Press and hold the |◀◀ button while playing a file.

- ↳ When the button is released, playback resumes those positions.
- If the starting position of a section (Ⓢ P.98) and the playback position are in the middle of a file, the recorder stops at that position.
- When the |◀◀ button is held down while the recorder is stopped, the recorder returns to the beginning of the file and then stops. If the |◀◀ button is still held down, the recorder moves back to the end of the previous file and continues fast rewinding.
- When the |◀◀ button is held down during playback and the recorder reaches the beginning of the file, the recorder starts playback from the beginning of that file.
- If the |◀◀ button is kept pressed while the recorder is stopped at the start of the top file, the recorder will fast rewind starting from the end of the last file.

File skip and section skip

Press the **▶▶|** button while the recorder is stopped.

- ▶ The recorder skips to a playback position or the starting position of a section, whichever is closer in the file, and stops.

After a stop position, if there is no playback position or a starting position of a section, the recorder will skip to a playback position in the next file then stop.

Press the **|◀◀** button when the recorder has stopped at the beginning of a file.

- ▶ The recorder skips to the Playback Position of the previous file and then stops.

Press the **|◀◀** button if the recorder has not stopped at the beginning of a file.

- ▶ The recorder skips to a playback position or the starting position of a section, whichever is closer in the file, then stops.

Press the **▶▶|** button during playback.

- ▶ The recorder skips three seconds forward or to the starting position of the next section, whichever is closer, and starts playing the file. After reaching the end of the file the recorder stops at the beginning of the file. The Playback Position is updated to the beginning position of the file at this time.

Press the **|◀◀** button during playback.

- ▶ The recorder skips three seconds back or to the starting position of the current section, whichever is closer, and starts playing the file. When the recorder reaches the beginning of a file the file plays from the beginning.
- The **[Skip Space]** (P.61) setting is invalid in the Audible mode.

Other information

Alarm message list

Message	Meaning	Explanation	Action
[Battery Low]	Low battery power.	Battery power is getting low.	Charge the batteries or replace them with new batteries (☞ P.15, P.17).
[File Protected]	Erase-locked.	Tried to delete a locked file.	Unlock the file (☞ P.53).
[Cannot record in this folder]	Not an audio-recording folder.	Recording has been attempted with a [Music] or [Podcast] folder.	Select a folder from among [A] to [E] and try to record again (☞ P.26, P.30).
[Index Full]	Index full.	The file is full of index marks (maximum of 16 (99*) marks).	Erase index marks that are no longer required (☞ P.45).
[Temp Mark Full]	Temp mark full.	The file is full of Temp marks (maximum of 16 (99*) marks).	Erase Temp marks that are no longer required (☞ P.45).
[Folder Full]	Folder full.	The folder is full of files (maximum of 200 files).	Erase unnecessary files (☞ P.48).
[Memory Error]	Error in the memory.	Error in the memory.	This is a malfunction, so go to the store where you purchased the recorder or an Olympus service station for repair (☞ P.112).
[Card Error]	Error in the memory.	microSD card is not recognized correctly.	Remove the microSD card, and put it again (☞ P.24 to P.25).
[License Mismatch]	Illegally copied file.	The music files copied illegally.	Erase the file (☞ P.48).
[Memory Full]	Zero remaining memory.	No remaining memory.	Erase unnecessary files (☞ P.48).
[No File]	No file.	No files were found in the folder.	Select another folder (☞ P.27 to P.30).
[Format Error]	Formatting error.	There was an error while formatting the recorder's memory.	Reformat the memory (☞ P.77).

Message	Meaning	Explanation	Action
[Can't make the system file. Connect to PC and delete unnecessary file]	The management file cannot be created.	The file for management cannot be created due to a shortage of capacity for remaining memory.	Connect the recorder to a computer and delete any unnecessary files.
[Cannot play this file]	File which cannot be played.	Incompatible format.	Please confirm the file that can be played on this recorder (≡ P.41).
[Please Select The File]	Unselected File	File is not selected.	Please select a file then carry out the operation (≡ P.27 to P.30).
[Same folder. Can't be moved (copied).]	File cannot be moved (copied).	Attempting to move (copy) into the same folder.	Please select another folder.
[Some files can't be moved (copied).]	File cannot be moved (copied).	Attempting to move (copy) a file to destination folder in which a file with the same file name exists.	Please select another file.
[This file can't be divided]	File which cannot be split.	Attempting to split a file other than MP3 or PCM files recorded by this recorder.	Please select another file.

* DM-670 only

Troubleshooting

Symptom	Probable cause	Action
Nothing appears on the display	The batteries are not loaded properly.	Verify that the batteries' polarities ⊕ and ⊖ are correct (☞ P.15).
	Battery power is getting low.	Charge the batteries or replace with new batteries (☞ P.15, P.17).
	The power is off.	Turn the power on (☞ P.20).
Won't start	Battery power is getting low.	Charge the batteries or replace with new batteries (☞ P.15, P.17).
	The power is off.	Turn the power on (☞ P.20).
	The recorder is in HOLD mode.	Release the recorder from HOLD (☞ P.21).
Unable to record	Low remaining memory.	Erase unnecessary files (☞ P.48).
	The maximum number of files has been reached.	Change to any other folder (☞ P.27 to P.30).
No playback sound heard	The earphone is connected.	Unplug the earphones to use the internal speaker.
	The volume level is set to [00].	Adjust the volume level (☞ P.38).
Recording level too low	The recording level has not been adjusted.	Adjust the recording level and then try recording once more (☞ P.54).
	The microphone sensitivity is too low.	Set [Mic Sense] to [High] or [Middle] (☞ P.53).
	This could potentially be because the output level for the connected external devices are too low.	Adjust the output level for the connected devices.
Recording level too high	The recording level has not been adjusted.	Adjust the recording level and then try recording once more (☞ P.54).
	This could potentially be because the recording level and output level for connected external devices are too high.	If you cannot record clearly even after adjusting the recording level, then adjust the output level for the connected devices (☞ P.54).
Voice files are not recorded in stereo	The connected external microphone is monaural.	When recording while an external monaural microphone is connected, sound will only be recorded by the L-channel.
	[Rec Mode] is set to a monaural recording mode.	Set [Rec Mode] to the stereo recording mode (☞ P.54).
	[Zoom Mic] is set to the + side.	Set [Zoom Mic] to [Off] (☞ P.55).

Symptom	Probable cause	Action
Cannot find the recorded Voice File	Wrong folder.	Switch to the correct folder (☞ P.27 to P.30).
Noise heard during playback	The recorder was shaken during recording.	_____
	The recorder was placed near a cell phone or fluorescent lamp while recording or during playback.	Move the recorder.
Unable to hear any sound from the earphone through the recording monitor	[Rec Monitor] is set to [Off].	Set [Rec Monitor] to [On] (☞ P.59).
Unable to erase the file	The file is locked.	Unlock the file (☞ P.53).
	The file is read-only.	Unlock the file or cancel the read-only setting of the file on the PC.
Unable to erase the folders	There is a file which cannot be recognized by the recorder in the folder.	Connect the recorder to your PC and erase a folder (☞ P.90).
Noise is audible through the recording monitor	Acoustic feedback is occurring.	When the built-in speaker amps and the like are connected there is a risk that audio feedback will occur while recording. It is recommended that you use earphones for the recording monitor, or turn the [Rec Monitor] to [Off] while recording (☞ P.59).
		Perform adjustments, such as further distancing the earphones from the microphones, not pointing the microphones at the earphones, or lowering the volume of the recording monitor.
Unable to set index marks, temp marks	The maximum number of marks has been reached.	Erase unnecessary marks (☞ P.45).
	The file is locked.	Unlock the file (☞ P.53).
	The file is read-only.	Unlock the file or cancel the read-only setting of the file on the PC.

Symptom	Probable cause	Action
Cannot recharge	[Battery] is set to [Alkaline].	When using the supplied rechargeable batteries, set the battery setting to [Ni-MH]. Also, please avoid using the batteries outside the recommended temperature range (☞ P.16, P.19, P.64).
	You have not pressed the ►OK button.	When using the USB connection, follow the confirmation display and press the ►OK button.
	[USB Class] is set to [Composite].	Set [USB Class] to [Storage class] (☞ P.76).
The PC is unable to recognize the recorder	[USB Connect] is set to [AC Adapter].	Set [USB Connect] to [PC] (☞ P.76).

Accessories (optional)

Accessories exclusive to the Olympus voice recorder can be purchased directly from Online Shop on our company's website. Sales of accessories are different according to the country.

- **Stereo microphone: ME15S**

The built-in large-diameter microphone enables sensitive stereo recording.

- **2-channel microphone (omni-directional): ME30W**

Two ME30 monaural microphones come in a set with a miniature tripod and a connection adapter. These are highly sensitive omni-directional microphones supported by plug-in power which are well-suited to recording musical performances.

- **Compact Gun Microphone (unidirectional): ME31**

The directional microphones useful for recordings such as outdoor recording of wild birds singing. The metal body provides a sturdiness to the high rigidity.

- **Compact zoom microphone (unidirectional): ME32**

The microphone is integrated with a tripod, making it suitable for when you wish to record from a distance, such as from your table at a meeting or conference.

- **Highly sensitive noise-cancellation monaural microphone (unidirectional): ME52W**

This microphone is used to record sound at a distance while minimizing surrounding noise.

- **Tie clip microphone (omni-directional): ME15**

Small concealing microphone with a tie-clip.

- **Telephone pickup: TP7**

Earphone type microphone can be plugged into your ear while phoning. The voice or conversation over the phone can be clearly recorded.

- **Ni-MH rechargeable battery: BR404**

High-efficiency rechargeable long life batteries.

- **USB connecting AC adapter: A514**

DC5V AC Adapter for USB connection.

- **Connecting cord: KA333**

Connecting cord which has stereo mini-plugs (ø3.5) with resistance at both ends. Use to connect from the earphone jack output of the recorder to the microphone input jack when recording. Converting plug adapters (PA331/PA231) which convert to the monaural mini plug (ø3.5) or monaural mini plug (ø2.5) are also enclosed.

- **Exclusive remote control set: RS30W**

When the receiver is plugged into the REMOTE jack the recorder's recording and stop functions can be operated through the remote control. The receiving position can be adjusted, thereby allowing you to operate the recorder from various different angles.

Specifications

General points

■ Recording format:

Linear PCM (Pulse Code Modulation)
MP3 (MPEG-1 Audio Layer3)
WMA (Windows Media Audio)

■ Input level:

- 70 dBv

■ Sampling frequency:

Linear PCM format

48 kHz 16 bit	48 kHz
44.1 kHz 16 bit	44.1 kHz
44.1 kHz mono*	44.1 kHz

MP3 format

320 kbps	44.1 kHz
256 kbps	44.1 kHz
128 kbps	44.1 kHz
mono	44.1 kHz

WMA format

128 kbps	44.1 kHz
64 kbps	44.1 kHz
32 kbps	22 kHz
mono	8 kHz

* DM-670 only

■ Maximum working output:

400 mW (8 Ω speaker)

■ Maximum headphone output:

≤ 150 mV (according to EN 50332-2)

■ Wide band characteristic headphone output:

75 mV \leq (according to EN 50332-2)

■ Recording medium:

Built-in NAND FLASH memory:

DM-670: 8 GB

DM-650: 4 GB

microSD card:

512 MB to 32 GB

■ Speaker:

Built-in $\varnothing 20$ mm round dynamic speaker

■ MIC jack:

$\varnothing 3.5$ mm mini-jack, impedance 2.2 k Ω

■ EAR jack:

$\varnothing 3.5$ mm mini-jack, impedance 8 Ω or more

■ Input power requirement:

Batteries:

AAA battery (LR03) or

Olympus Ni-MH rechargeable battery

External power supply:

USB connecting AC adapter (A514) 5 V

■ External dimensions:

110.8 mm \times 39.8 mm \times 15.4 mm
(without protrusions)

■ Weight:

86 g (including batteries)

■ Operating temperature:

0°C - 42°C / 32°F - 107.6°F

Frequency response

■ During recording mode (Microphone jack):

Linear PCM format

48 kHz 16 bit	40 Hz to 23 kHz
44.1 kHz 16 bit	40 Hz to 21 kHz
44.1 kHz mono*	40 Hz to 21 kHz

MP3 format

320 kbps	40 Hz to 20 kHz
256 kbps	40 Hz to 20 kHz
128 kbps	40 Hz to 17 kHz
mono	40 Hz to 13 kHz

WMA format

128 kbps	40 Hz to 19 kHz
64 kbps	40 Hz to 16 kHz
32 kbps	40 Hz to 9 kHz
mono	40 Hz to 3 kHz

* DM-670 only

■ During recording mode (Built-in microphone):

20 Hz to 20 kHz ([**Central Mic ON**])

70 Hz to 20 kHz ([**Central Mic OFF**])

(However, when recording in the MP3 format or the WMA format, the upper limit value of the frequency response depends on each recording mode)

■ During playback mode:

20 Hz to 20 kHz

Guide to battery life

The following values are strictly references.

■ **Alkaline batteries:**

Recording mode		Built-in stereo microphone (During recording mode)	Earphone playback (During playback mode)
Linear PCM format	44.1 kHz 16 bit	39 h.	41 h.
MP3 format	320 kbps	37 h.	48 h.
WMA format	128 kbps	38 h.	47 h.
	mono	46 h.	51 h.

■ **Ni-MH Rechargeable batteries:**

Recording mode		Built-in stereo microphone (During recording mode)	Earphone playback (During playback mode)
Linear PCM format	44.1 kHz 16 bit	29 h.	30 h.
MP3 format	320 kbps	27 h.	34 h.
WMA format	128 kbps	28 h.	33 h.
	mono	33 h.	37 h.

Note

- Battery life is measured by Olympus. It varies greatly according to the type of batteries used and the conditions of use.

Guide to recording times

The following values are strictly references.

■ Linear PCM format:

Recording mode	Built-in memory		microSD card			
	DM-670 (8 GB)	DM-650 (4 GB)	2 GB	4 GB	8 GB	16 GB
48 kHz 16 bit	10 h. 55 min.	5 h. 35 min.	2 h. 45 min.	5 h. 30 min.	11 h. 5 min.	22 h. 20 min.
44.1 kHz 16 bit	11 h. 50 min.	6 h. 5 min.	2 h. 55 min.	6 h.	12 h. 5 min.	24 h. 15 min.
44.1 kHz mono*	23 h. 30 min.	—	5 h. 55 min.	12 h.	24 h. 10 min.	48 h. 35 min.

■ MP3 format:

Recording mode	Built-in memory		microSD card			
	DM-670 (8 GB)	DM-650 (4 GB)	2 GB	4 GB	8 GB	16 GB
320 kbps	52 h. 30 min.	26 h. 30 min.	13 h.	26 h. 30 min.	53 h.	107 h.
256 kbps	65 h. 30 min.	33 h. 30 min.	16 h. 30 min.	33 h.	66 h. 30 min.	134 h.
128 kbps	131 h.	67 h.	33 h.	66 h.	133 h.	268 h.
mono	262 h.	134 h.	66 h.	132 h.	267 h.	536 h.

■ WMA format:

Recording mode	Built-in memory		microSD card			
	DM-670 (8 GB)	DM-650 (4 GB)	2 GB	4 GB	8 GB	16 GB
128 kbps	128 h.	65 h. 30 min.	32 h.	64 h. 30 min.	130 h.	262 h.
64 kbps	256 h.	131 h.	64 h. 30 min.	129 h.	261 h.	523 h.
32 kbps	513 h.	262 h.	128 h.	259 h.	522 h.	1046 h.
mono	2007 h.	1026 h.	502 h.	1014 h.	2042 h.	4089 h.

* DM-670 only

Notes

- Available recording time may be shorter if many short recordings are made (The displayed available recording time and recorded time are approximate indications).
- Variations in the available recording time will arise as there may be differences in the available memory depending on the microSD card.

Maximum recording time per file

- The maximum capacity for a single file is limited to approx. 4 GB for WMA and MP3.
- Regardless of the memory remaining amount, the longest sound recording time per file is restricted to the following value.

Linear PCM format

48 kHz 16 bit	approx. 3 h.
44.1 kHz 16 bit	approx. 3 h. 20 min.
44.1 kHz mono*	approx. 6 h. 40 min.

MP3 format

320 kbps	approx. 29 h. 40 min.
256 kbps	approx. 37 h. 10 min.
128 kbps	approx. 74 h. 30 min.
mono	approx. 149 h.

WMA format

128 kbps	approx. 26 h. 40 min.
64 kbps	approx. 26 h. 40 min.
32 kbps	approx. 53 h. 40 min.
mono	approx. 148 h. 40 min.

* DM-670 only

Specifications and design are subject to change without notice.

Technical assistance and support

The following are contact information for technical support for Olympus recorders and software only.

- **Technical Hotline Number in the U.S. and Canada**

1-888-553-4448

- **User Support E-mail address in the U.S. and Canada**

distec@olympus.com

- **Technical Hotline Number in Europe**

Toll free number: 00800 67 10 83 00

available for Austria, Belgium, Denmark, Finland, France, Germany, Italy, Luxemburg, Netherlands, Norway, Portugal, Spain, Sweden, Switzerland, United Kingdom

Charged numbers for the Rest of Europe

+ 49 180 567 1083

+ 49 40 23773 4899

- **User Support E-mail address in Europe**

dss.support@olympus-europa.com

6

Technical assistance and support

For customers in Europe:



"CE" mark indicates that this product complies with the European requirements for safety, health, environment and customer protection.



This symbol [crossed-out wheeled bin WEEE Annex IV] indicates separate collection of waste electrical and electronic equipment in the EU countries. Please do not throw the equipment into the domestic refuse. Please use the return and collection systems available in your country for the disposal of this product.

Applicable Product: DM-670/DM-650



This symbol [crossed-out wheeled bin Directive 2006/66/EC Annex II] indicates separate collection of waste batteries in the EU countries. Please do not throw the batteries into the domestic refuse. Please use the return and collection systems available in your country for the disposal of the waste batteries.

EN

OLYMPUS®

OLYMPUS IMAGING CORP.

Shinjuku Monolith, 3-1 Nishi-Shinjuku 2-chome, Shinjuku-ku, Tokyo 163-0914, Japan.

Tel. +81 (0)3-3340-2111

<http://www.olympus.com>

OLYMPUS EUROPA HOLDING GMBH

(Premises/Goods delivery) Wendenstrasse 14-18, 20097 Hamburg, Germany.

Tel. +49 (0)40-237730

(Letters) Postfach 10 49 08. 20034 Hamburg, Germany.

<http://www.olympus-europa.com>